

CEMP Design Guide 1110-3-124	Department of the Army U.S. Army Corps of Engineers Washington, DC 20314-1000	DG 1110-3-124 August 1976
	ARTS AND CRAFTS CENTERS	
	Distribution Restriction Statement Approved for public release; distribution is unlimited.	

DESIGN GUIDE
ARTS AND CRAFTS
CENTERS

ENGINEERING DIVISION
MILITARY CONSTRUCTION DIRECTORATE
OFFICE OF THE CHIEF OF ENGINEERS
DEPARTMENT OF THE ARMY
WASHINGTON, DC 20314

AUGUST 1976

LIMITED DISTRIBUTION

Foreword

DG 1110-3-124

August 1976

The Design Guide (DG) series has been established to replace material previously issued under the standard design medium by the Engineering Division, Military Construction Directorate, Office of the Chief of Engineers, U.S. Army.

This guide governs the design of Army Arts and Crafts Centers. The objectives of the Army Arts and Crafts Program are to provide military personnel and their families the opportunity to further their interests and knowledge in the arts and crafts, improve their level of individual skills, and develop their innate creative abilities; to contribute to the cultural awareness and enhancement of the military community and support the Army's individual development programs; to offer a diversified and balanced program to meet the varied interests and needs of the military community under differing geographic locations and duty assignments.

The guide is intended not only to state basic criteria, but also to provide a means by which the user of the guide can apply the criteria in individual ways to respond to local requirements. This guide is applicable to all new construction projects for Army Arts and Crafts Centers and projects involving modernization of existing facilities.

Detailed development of this guide was under the direction of the Special Projects Section, Structures Branch of the Engineering Division. Major parts of the material contained herein are based on the results of an architectural services contract with the firm of McLeod Ferrara Ensign, Washington, D.C. under Contract No. DACA73-73-C-008. The functional requirements in this guide have been developed in conjunction with, and approved by, the Recreation Directorate of the U.S. Army Adjutant General Center, (DAAG-RE).

Distribution of this guide is limited. Additional essential copies are available from the OCE Publications Depot, 890 South Pickett Street, Alexandria, Virginia 22304.

Users are invited to send comments and suggested improvements to HQDA (DAEN-MCE-A), Washington, D.C. 20314.

FOR THE CHIEF OF ENGINEERS:

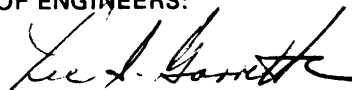

LEE S. GARRETT
Chief, Engineering Division
Directorate of Military Construction

Contents

CHAPTER 1 INTRODUCTION

1-1	PURPOSE	3
1-2	PRIMARY REFERENCES	3
1-3	SCOPE	4
1-4	EMPHASIS	4
1-5	RESPONSIBILITIES	5

CHAPTER 2 GENERAL CONSIDERATIONS

2-1	THE ARMY ARTS AND CRAFTS PROGRAM.	7
2-2	ARTS AND CRAFTS CENTERS.	8
2-3	PARTICIPANTS	9
2-4	CLIMATIC INFLUENCES	10
2-5	SITING	11
2-6	LANDSCAPE PLANTING	12
2-7	ARCHITECTURAL CHARACTER.	13
2-8	INTERIOR DESIGN	14
2-9	FLEXIBILITY	16
2-10	SYSTEMS BUILDING	17
2-11	ENERGY CONSERVATION	18
2-12	MINIMIZING MAINTENANCE AND VANDALISM	19
2-13	FOUND SPACE IN EXISTING BUILDINGS	20

CHAPTER 3 FUNCTIONAL SPACE REQUIREMENTS

3-1	GENERAL	25
3-2	HANDCRAFTED POTTERY AND CERAMICS	26
3-3	GLASSBLOWING	28
3-4	DRAWING AND PAINTING	30
3-5	JEWELRY AND ART METAL	32
3-6	WEAVING, TEXTILES AND GENERAL HANDCRAFTS	34
3-7	SCULPTURE AND THREE-DIMENSIONAL DESIGN	36
3-8	PHOTOGRAPHY	38
3-9	WOODWORK AND REPAIR	42
3-10	SUPPORT ACTIVITIES	46
3-11	SUMMARY OF SPACE ALLOCATIONS	48

CHAPTER 4 SPACE PLANNING CONCEPTS

4-1	CONCEPTUAL DIAGRAMS	51
4-2	AFFINITY MATRIX	54
4-3	FUNCTIONAL LAYOUTS	55

CHAPTER 5 ILLUSTRATIVE EXAMPLES

5-1	NEW FACILITY DESIGN	59
5-2	MODIFICATION AND EXPANSION OF EXISTING FACILITIES	62

CHAPTER 1

Introduction

1-1 Purpose

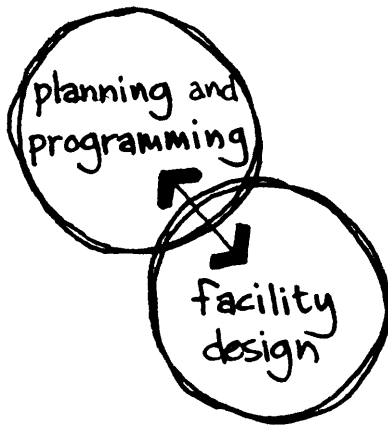

Guide Use

a. This guide contains design criteria for Army Arts and Crafts Centers which are in some instances referred to as Skill Development Centers. The term Skill Development Center will be used only when preparing budget documents, DD forms 1391 which summarize project requirements for the Military Construction, Army (MCA) Program and for nonappropriated funded projects as stated in AR 28-1 and AR 230-1.

b. The primary purpose of this guide is to provide criteria for design personnel who prepare and evaluate project designs. This guide also provides general guidance for installation personnel and Corps of Engineers field offices in planning and programming project requirements.

c. In addition, it is expected that facility managers will find this guide useful in planning improvements or in better utilizing existing Arts and Crafts Centers or other suitable facilities.

d. This guide is directed toward improving early design decisions and toward the development of realistic, cost-effective spaces in conjunction with the regulations and criteria references below. It should be used in the preparation of project development brochures, project data forms, design analyses and drawings.

1-2 Primary References

- a. DOD 4270.1-M, Department of Defense *Construction Criteria Manual*.
- b. AR 28-1, *Army Recreation Services*.
- c. AR 415-10, *General Provisions for Military Construction*.
- d. AR 415-15, *MCA Program Development*.
- e. AR 415-17, *Empirical Cost Estimates for Military Construction*.
- f. AR 415-20, *Project Development and Design Approval*.
- g. ER 1110-345-700, *Design Analysis*.

1-3 Scope

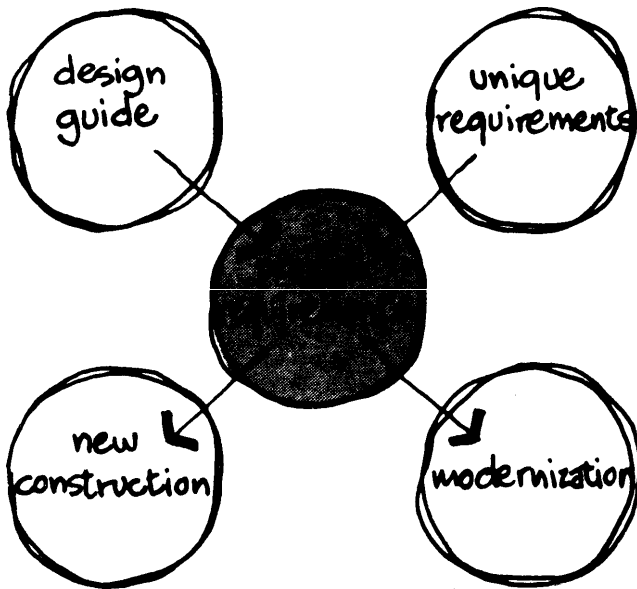

Application

a. This design guide is applicable to all new construction projects for Army Arts and Crafts Centers. It is also applicable, as general guidance, to projects involving the modernization or conversion of existing facilities.

b. While this guide is the basic design criteria document for Arts and Crafts Centers, it is not intended to provide all of the information required for successful preparation of project designs. Additional information must be obtained from the installation pertaining to the unique requirements of the users and the locational constraints and opportunities of the site.

c. Maximum space allowances for Arts and Crafts Centers are discussed in Department of Defense *Construction Criteria Manual*, 4270.1-M Chapter 3. These allowances are based on the authorized projected military population of the using installation. Military population is defined as the military strength plus 40 percent of the dependent population and 10 percent of the retired military personnel living in the area. Although an Arts and Crafts Center of 20,650 square feet which serves a military population of 20,000 to 25,000 was chosen to illustrate the criteria contained in the guide, the criteria contained herein are applicable to all sizes of facilities.

d. Example designs are provided in Chapter 5 for both a new facility of 20,650 square feet, and for modernizing and expanding an existing facility of 9400 square feet.

1-4 Emphasis

a. Special emphasis shall be placed on the quality of architectural design since it vitally affects the longevity, economics, usefulness, and efficiency of the centers. In addition to considerations of life-cycle economy and functional efficiency, a prime requirement of the architectural design shall be the attractiveness of both the interior and exterior facilities. An overall interior design scheme should be developed in conjunction with the building design of all new facilities and of major alterations to existing facilities. Items that must be procured using other than construction funds should be programmed early and scheduled for procurement as appropriate.

b. As part of the overall design, a users information book should be assembled to help provide instructions on maintaining and operating the facility to maximum advantage. The book should cover major design intentions for the utilization of the facility and its interior spaces, and related information concerning environmental controls, mechanical facilities and housekeeping in general.

1-5 Responsibilities

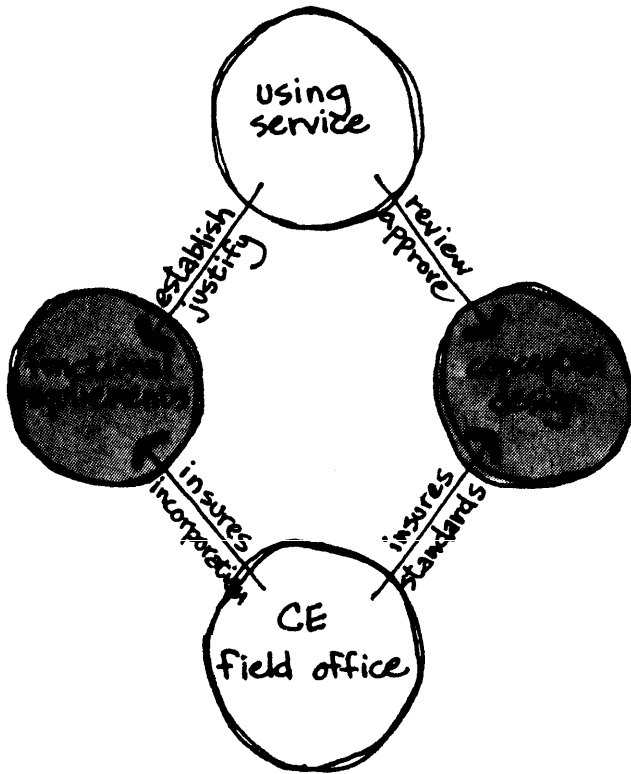

Project Responsibilities

a. The using service for individual MCA projects is defined in AR 415-10 and its responsibilities are outlined in AR 415-20. The using service is responsible for:

- (1) Establishment of specific project functional requirements within the parameters, contained in this guide.
- (2) Justification of functional requirements falling outside the parameters of this guide.
- (3) Obtaining installation action to gain site approval if the project is not sited in accordance with the approved master plan.
- (4) Preparation and submission of project data, DD Form 1391 in accordance with AR 415-15.
- (5) Preparation and submission of the project development brochure required by AR 415-20.
- (6) Review and approval of concept design drawings to certify compliance with functional requirements.

b. The Corps of Engineers field office responsible for design will insure that:

- (1) Functional requirements of the using service are incorporated into the design.
- (2) Requirements of the using service are in accordance with the criteria contained herein.
- (3) Major deviations from this guide as requested by the using service are explained in the project design analysis.
- (4) Quality standards for overall design are emphasized as stated herein.
- (5) Assemblage of user information is complete, and is provided, together with the completion records required by AR 415-10, to the using service.

CHAPTER 2

General Considerations

2-1 The Army Arts and Crafts Program

a. The Arts and Crafts Program includes fine arts, hand-crafts and skills required for constructive use of tools, innovative and manipulative use of materials, and application of technical knowledge, discipline and judgement. Activities are planned for both beginner and professional to stimulate new interests and progressively to increase their competence. Informal instruction is provided for individuals, and regularly scheduled classes are held for groups.

b. Members of the program are encouraged to share their accomplishments with the civilian community through open-house type activities and off-post exhibitions, workshops, fairs and similar activities.

c. A minimum of seven basic arts and crafts are offered to the person pursuing "creative development" of his/her leisure time:

HANDCRAFTED POTTERY AND CERAMICS
DRAWING AND PAINTING
JEWELRY AND ART METAL
WEAVING, TEXTILES AND GENERAL HANDCRAFTS
SCULPTURE AND THREE-DIMENSIONAL DESIGN
PHOTOGRAPHY
WOODWORK AND REPAIR

d. A specialized facility for an Auto Crafts Center (auto self-help garage) is also authorized for the repair and maintenance of personal vehicles. A separate design guide (DG 1110-3-126) has been prepared for this type of facility.

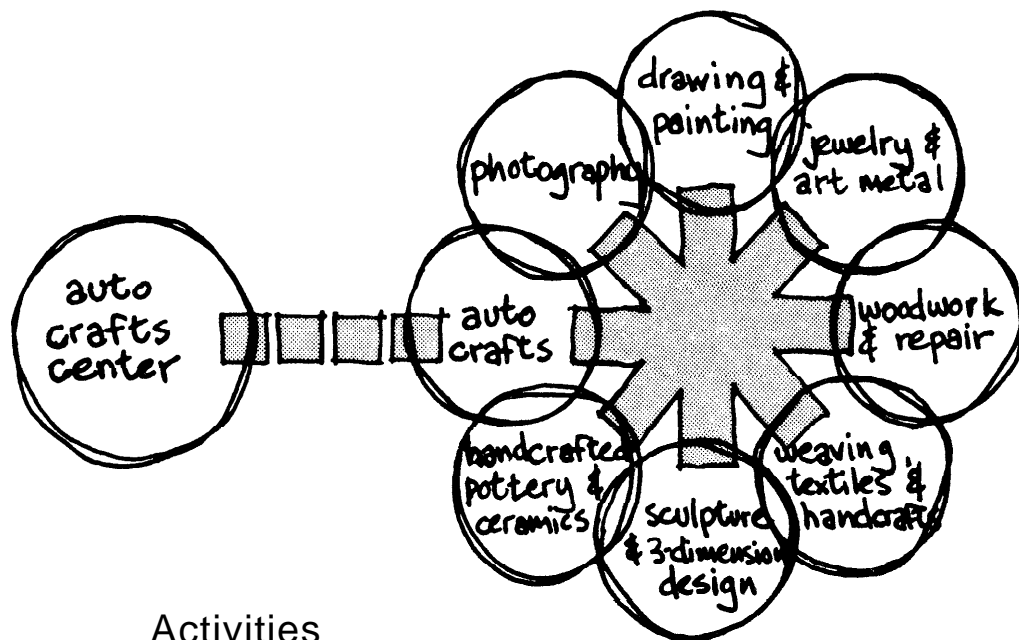

2-2 Arts and Crafts Centers

a. To house the arts and crafts program one multiple-type Arts and Crafts Center is the authorized minimum requirement for each installation.

b. A typical Arts and Crafts Center may be divided into four basic functional areas; a shop for woodworking; an area for photography; a multi-purpose studio for arts and crafts; and utility and service areas. Variations may be made in the allocation of space for specific arts and crafts activities, as long as the total authorized space allowances are not exceeded. Criteria for the allocation of space within the center is given in Chapter 3.

c. The Arts and Crafts Center also serves as the Arts and Crafts Program Administrative Center for an installation. Branch Arts and Crafts Centers and/or specialized facilities may be authorized for activities such as boat building, electronics, and woodworking.

d. Since participants will include dependents and retirees, Arts and Crafts Centers must be accessible to and usable by the physically handicapped. Refer to ER 1110-1-102, *Design for the Physically Handicapped*, for guidance.



Functional Areas

2-3 Participants

a. The Arts and Crafts Center attracts a diversified cross section of the installation community. There are often correlations between particular activities and various categories of users. For example, military career and retired personnel usually make heavy use of woodworking shops, younger enlisted men are the primary participants in photography, and dependents are often most interested in the broad range of general handicrafts.

b. Transient and permanent post personnel also have different program needs. Transient personnel have less time to devote to long-term projects and are more likely to use the center for smaller projects and brief periods of time at irregular intervals.

c. No arts and crafts program can, or should, remain unchanged for very long. Directors should always be on the alert to detect new trends. The average Army's recruit today may have different interests than his predecessor, and his involvement in craft pastimes will not necessarily be the same. As a result, the popularity of the various arts and crafts activities also change. For example, there was little demand for glassblowing in the past, but now it is rapidly increasing.

d. Many factors influence the number of participants in an arts and crafts program, but the most important is probably the effectiveness and enthusiasm of the director and staff. The location and type of installation, competing civilian facilities, climate and cultural attitudes all effect participation in arts and crafts.

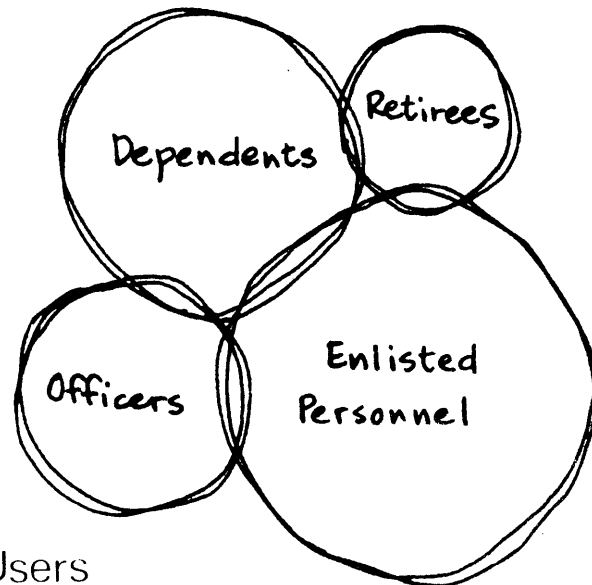

2-4 Climatic Influences

a. Building designs for Arts and Crafts Centers should be responsive to regional variations in climate. This affects not only building orientation and fenestration but also use of outside space for activities which may be performed in either open or covered work areas. In reference to authorized space allowances, covered areas are calculated at one-half of the gross square foot area of indoor areas. In mild climate zones, advantage can be made of this factor to increase the usable amount of work area within the authorized programmed space allowance.

b. With the growing concern for energy resources it is important to begin considering conservation factors at the early planning stages. For example, in more severe climates, buildings should be compact to minimize perimeter walls. They should be oriented to reduce exposure on prevailing weather sides and to reduce heat loss. In temperate locations, full advantage should be made of overhangs, setbacks and orientation to shade windows and utilize prevailing breezes, thus reducing the need for mechanical cooling. Covered exterior work areas may be provided in addition to indoor space.

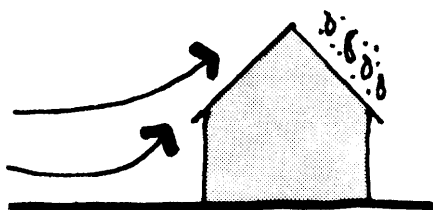

(1) Severe climate dictates compact building forms.

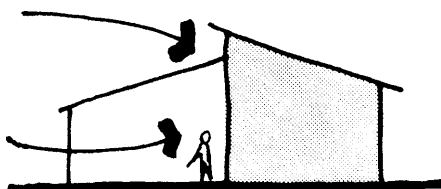

(2) Temperate climate permits the use of natural ventilation and light.

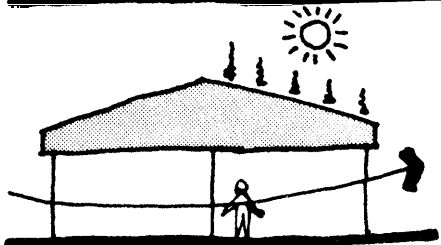

(3) Warm climate permits maximum use of covered exterior work areas in addition to indoor space.

2-5 Siting

a. Installation master plans are guides for future land development and indicate specific locations of proposed facilities. They evolve from an analysis of requirements for housing, support activities and military operations. Ecological considerations, utility and transportation modes and natural characteristics of the terrain are some of the factors which contribute to the formulation of the plan.

b. Arts and Crafts Centers generate a large amount of activity. They are places of excitement where creative things happen. Although traffic and noise problems which result from the operations of the center must be considered in each design solution, the facilities themselves generally do not disturb their neighborhoods and therefore need not be isolated. In fact, the Arts and Crafts Center might well be part of a larger social/recreational complex which offers numerous leisure activities in much the same manner that a shopping mall gives its patrons purchasing choices. Libraries, theaters, recreation centers and snack bars are all compatible facilities that might be mutually supportive of a large complex. Refer to TM 5-803-6, *Site Planning of Community Centers*, for guidance.

c. At most installations there is one Arts and Crafts Center. However, when the installation is large, several smaller centers should be considered because the areas served by a single center might be too large to be convenient to the majority of the prospective users. If a center is sited in a complex with other facilities for leisure activities, or into a central core area of shopping, recreation and service facilities, then the entire complex can be more easily served by both public transportation and service vehicles.

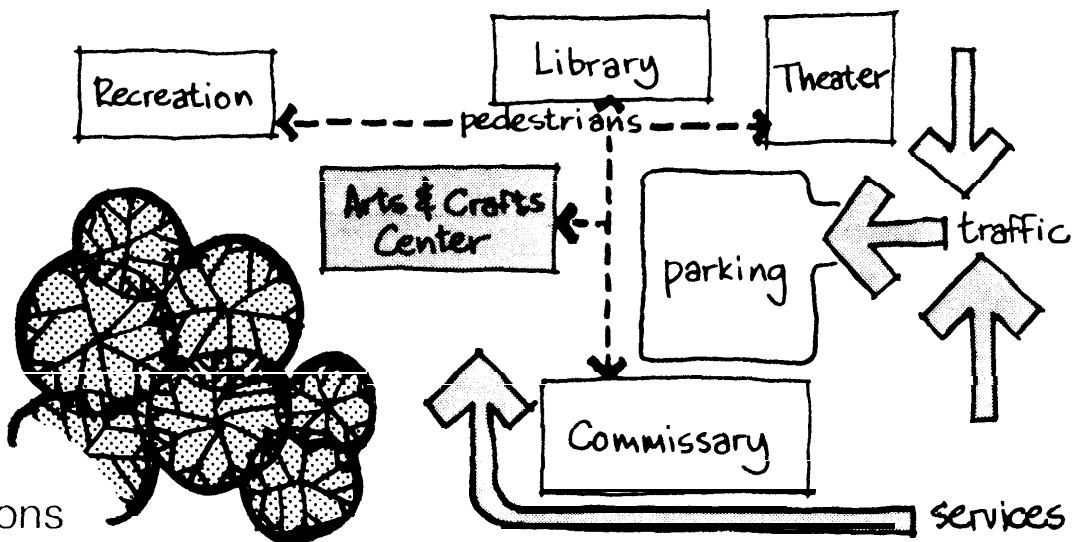

Site Considerations

2-6 Landscape Planting

a. Landscaping of Arts and Crafts Centers can not only improve their aesthetic character but serve other purposes as well. Landscaping can help create or define outdoor work areas, direct the flow of traffic, muffle noise and dirt, screen objectionable views, control sun, wind and rain, reduce glare and conserve energy. Vegetation adds to the environmental qualities of an area by controlling erosion, sustaining wildlife, absorbing carbon monoxide and dioxide, and discharging oxygen.

b. Landscape planting at military installations should be designed to minimize maintenance and vandalism as much as possible. However, planting should not be so minimal or so protected that it defeats its functional and aesthetic purposes.

c. Paving materials, planters, benches, and other outdoor furnishings should be selected for durability as well as texture, scale, shape and color.

d. Desirable plants are those most resilient or defensive in nature, with tough leaves or bark or fine thorns. Selections should be made from evergreens and those deciduous trees that blossom in spring, bear foliage in the summer and change color in the fall to produce continuing interest.

e. Terraces, walks, walls, outdoor furnishings, ground cover, and planting contribute to the character of outdoor space at the Arts and Crafts Center itself and the total landscaping program of the installation.

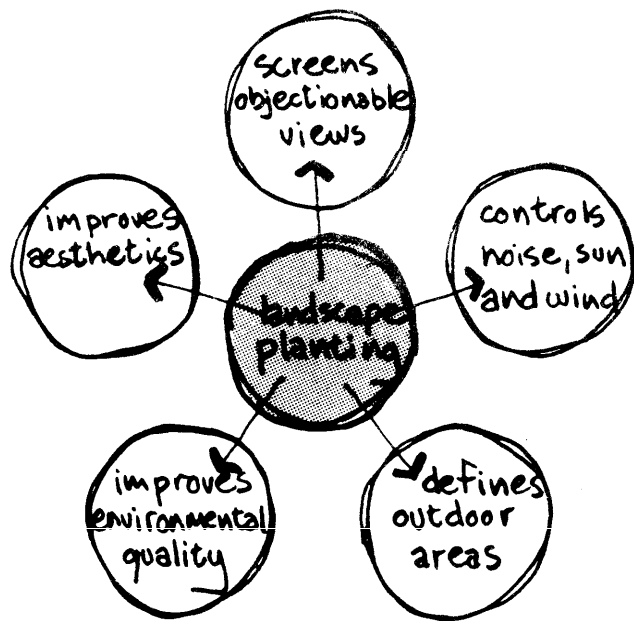

Landscape Functions

2-7 Architectural Character

a. In Arts and Crafts Centers, emphasis is placed on the creation of objects of beauty and function. Therefore, it stands to reason that the centers themselves should reflect similar concerns with good design and functional planning.

b. Military posts are dispersed worldwide and, in a broad sense, local commands should be sensitive to regional characteristics of architectural style, scale, form, materials and composition. This does not mean that the buildings on any one post should be copies of a particular architectural style. Architecture expresses the culture and technology of its own time, and military construction should be no exception. Architectural character should be an outgrowth of function and form and for an Arts and Crafts Center, it should be unpretentious and humane.

c. Arts and Crafts Centers should be inviting places whose exteriors express some of the excitement of the activities within. Tasteful bulletin boards, window displays, signage, entrances and landscaping should all attract the casual passerby. The building itself should not strike a jarring note within its neighborhood.

d. The appropriateness of building materials and scale will depend on the nature of the installation and the character of the ambient buildings. The building should exemplify desirable characteristics of local construction practices, with materials chosen on the basis of availability, economy, durability and capability to generate visual interest through color and texture.

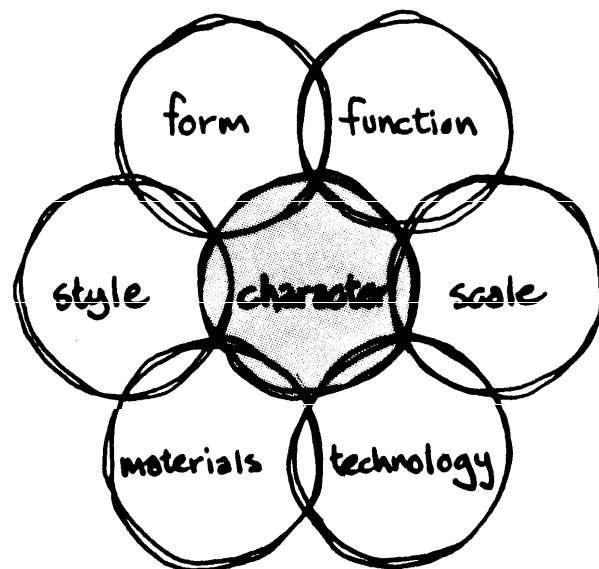

Character Determinate

2-8 Interior Design

a. Interior design features must be developed in coordination with the architectural design. All features of the building relative to the interior design, whether they are furnished and installed as part of the construction contract or provided later by the using service, must be developed as an overall scheme. Graphic design and signage should be included as part of the overall design to identify activities and facilitate functional effectiveness. Requirements must be coordinated with the using service and the installation.

b. The costs of all items of equipment and furnishing which are permanently built-in or attached to the structure, as defined in AR 415-17, are normally considered part of the construction contract. Other items which are loose, portable or can be detached from the structure without tools, are generally provided by the using service under separate contract. Interior building surfaces, paint colors, floor coverings, window coverings as required, graphics and signage will be specified as part of the construction contract in coordination with the overall design. Furniture must be identified for procurement by others.

c. Drawings and schedules for items not included in the construction contract must be provided in a format that can be readily issued to and be understood by installation personnel who are responsible for procurement, and personnel who are responsible for component placement and utilization after delivery. Display sheets consisting of placement plans, catalog illustrations, material/color samples and perspective sketches of typical spaces; together with procurement lists, source data and cost estimates should be developed as appropriate to accomplish this objective. Clear coordination between these drawings and schedules, and the finish schedules under the construction contract must be evident.

d. Use of color in Army facilities is limited to a practical number selected from Federal Standard 595A, Colors. General guidance for color selection is provided in TM 5-807-7, *Colors for Buildings*. Color should be used to stimulate human physical and emotional reactions and to enhance the overall functionality of the Arts and Crafts Center. In critical seeing areas, glare, brilliant colors and great brightness differences, both in the lighting system and in the color of walls, floors, furnishings and equipment, should be avoided.

e. Interior finishes must be appropriate for the designed function of the building and spaces. Selection of materials should be based on low maintenance qualities considering the anticipated use, life-cycle cost impact, fire and other safety requirements. The color, texture and pattern of materials should complement the overall design scheme. Native (local) materials should be used to the greatest

extent practicable. Long-life materials such as stone, tiles, woods, plastics, and vinyls should be selected to provide attractive colors, textures and patterns which are relatively easy and inexpensive to refurbish and can be kept fresh and up-to-date in appearance.

f. Wallgraphics, while mainly decorative, may frequently incorporate useful information such as names, direction indicators, safety information, etc. When professionally done, they can be most effective in livening up dead spaces and producing interest such as in large rooms or circulation spaces.

g. Signage requirements must be defined in terms of an overall signage system. Detailed requirements of the using service must be coordinated at the local level. The system should assure maximum economy, ease of procurement and installation, and standardization of application throughout the Arts and Crafts Center. It should also inhibit vandalism but be flexible enough to enable the addition or deletion of information.

h. The *Catalog of Army Arts and Crafts Program Equipment* contains illustrations and specifications for equipment for the Army Arts and Crafts Program. *Essential Facilities and Equipment for Program Operations, Arts and Crafts Program*, lists essential equipment and budget prices. However, none of these sources cover all program items and costs, and specifications should be obtained from three major sources:

- (1) Army schedules for government furnished standard items as indicated by the various commands.
- (2) Schedules from GSA and Federal Prison Industries.
- (3) Commercial supply firms.

i. Furniture is an integral part of the overall scheme, and must be closely coordinated with the selection of colors and finish materials for consistency in appearance and quality. Detailed requirements are covered in Chapter 3, Functional Space Requirements. Items which will be procured as part of the construction contract and those which will be procured by others must both be specified.

j. Sources for selection and procurement of furnishings are listed in the GSA *Federal Supply Schedules*, the *Federal Prison Industries Schedule of Products* and the *GSA Supply Catalog*. Procurement by the using service from these sources is mandatory when the items covered meet technical requirements. For items not listed in the mandatory sources above but which are part of the overall design scheme, appropriate guidance must be provided

for procurement by the using service, from commercial firms.

k. Careful attention must be given to all interior furnishings to insure that the type of furniture chosen conforms to standards appropriate for the use they will receive. Parts that receive the most wear should be replaceable, and finishes should be able to sustain regular cleaning. Colors, textures, sizes, proportions, and shapes are important factors that should be considered. Furniture and equipment must withstand loading conditions without damage, and edges and surfaces should be smooth and rounded.

l. The proper spacing of equipment and adequate power supply is essential for the safe operation of the shops. The maximum number of tools is governed by the amount of area required for safe operation. Islands of space around most power tools is essential for safety. These requirements are identified in Chapter 3.

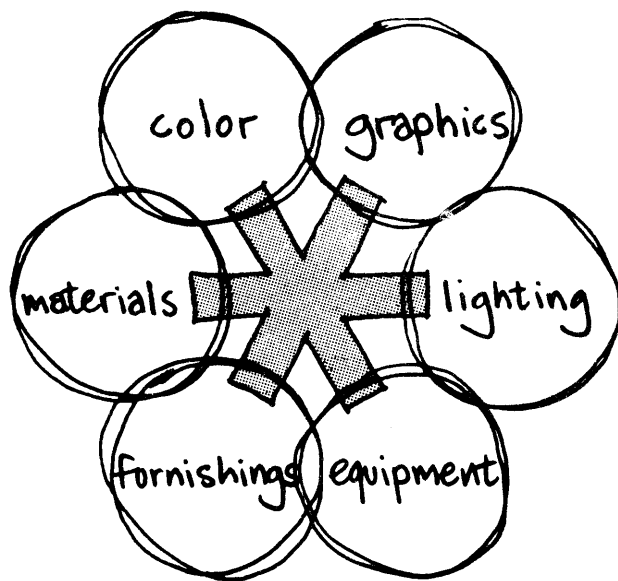

Interior Design Elements

2-9 Flexibility

a. As mentioned earlier, Arts and Crafts Centers will continually change as new trends and interests develop. Flexibility can prolong the usefulness of a facility to serve these ever changing demands. Physical flexibility is a function of and can be symbolized by five terms: Spatial variety, adaptability, changeability, multiple function and structural appropriateness.

- (1) Spatial variety implies that different kinds of spaces are provided for different needs.
- (2) Adaptability implies that changes can be made in response to new or different needs as they arise.
- (3) Changeability implies that changes can be made easily in short periods of time.
- (4) Multiple function implies that the space will accommodate a multitude of activities.
- (5) Structural appropriateness implies that spatial changes can occur without changing the building structure.

b. Unless the facility is designed to allow for easy modification, changing requirements could make the centers functionally obsolete before their physical life is depleted.

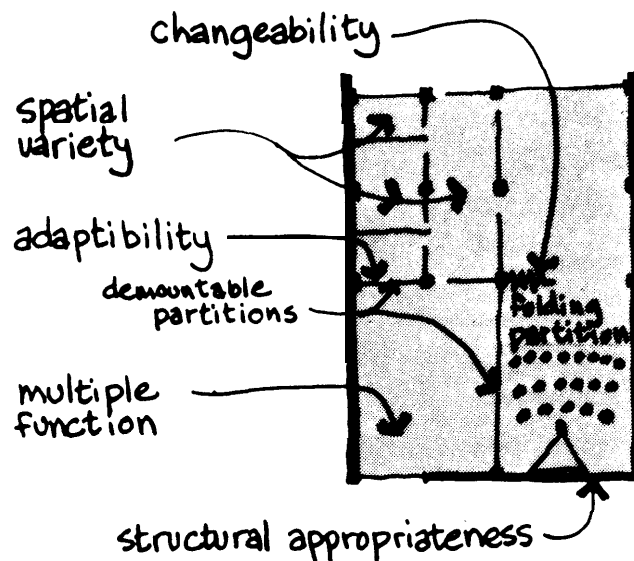

Physical Flexibility

2-10 Systems Building

a. Systems building is now much more than the experiment it was a few short years ago, and its methods and materials are readily available throughout the country. Simply, systems building is the long-overdue application of modern man's production techniques to the building process, and is taking on an expanded role in the construction industry.

b. Systems built facilities are composed of sub-systems which typically include structural framing systems, lighting and ceiling systems, heating, ventilating and air-conditioning systems, and interior partitioning systems. The best examples of systems built facilities offer economy of both time and money committed to construction, a high degree of quality control, and maximum flexibility of space.

c. Building systems selected should be those which are most economical and suitable based on comparative cost studies for the buildings.

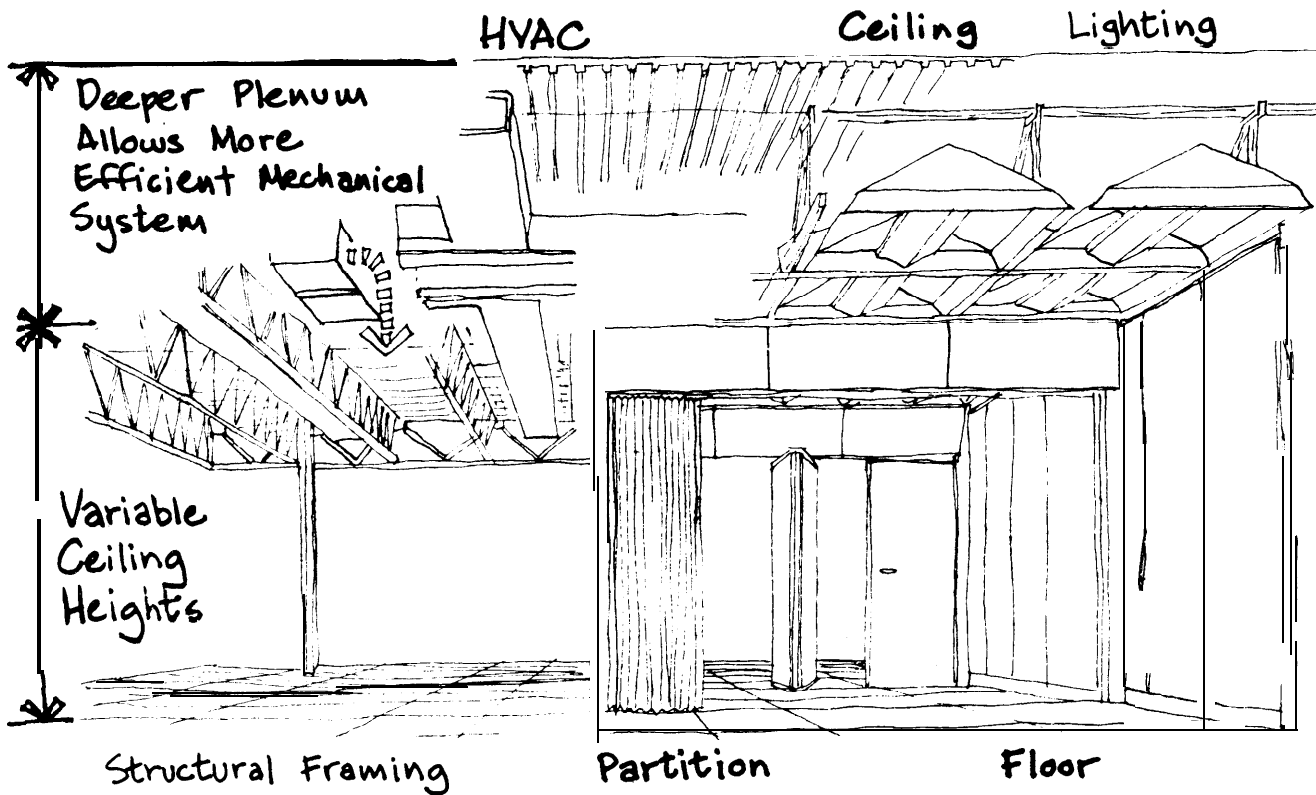

Sub-Systems

2-11 Energy Conservation

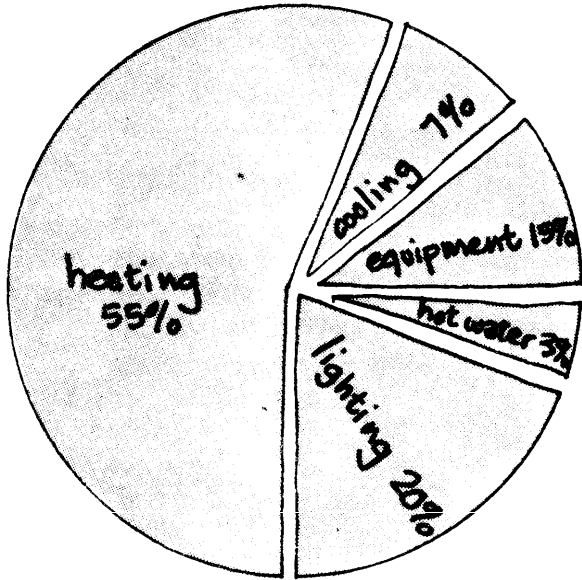

Typical Annual Energy Consumption

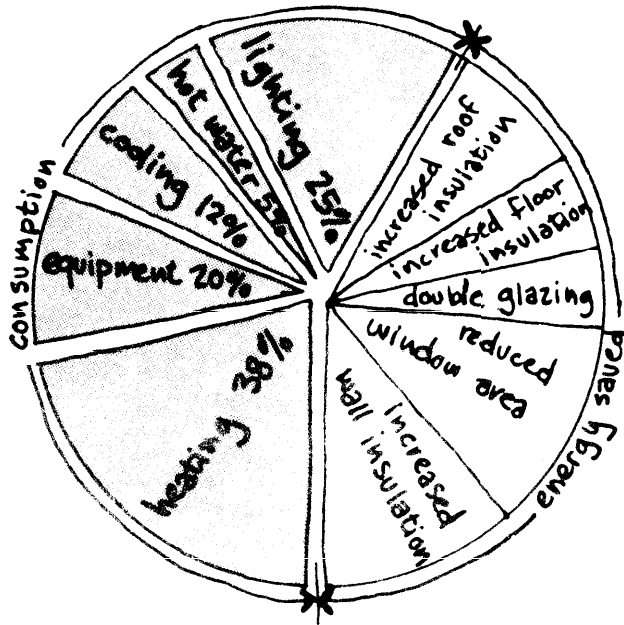

Possible Savings in Annual Energy Consumption

a. With decreasing energy sources, the design of Arts and Crafts Centers must consider methods of energy conservation. New construction offers a variety of methods to conserve energy. The skillful exploitation of local climate conditions, topography, trees, solar exposure and other natural features, combined with building orientation, compact building shapes, and wall shading, offer opportunities for energy conservation. The simple consideration that each side of a building may require different treatment depending on its exposure is often overlooked in designing an energy efficient building.

b. An obvious area to consider is the mechanical and electrical design since this is the heart of energy consumption. Since there is a certain amount of heat buildup from the operation of equipment within the Arts and Crafts Center, a heat recovery system could put excess energy to good use. Long-range (life-cycle) costing, which compares initial capital improvement costs to the life time operating and maintenance costs, is effective in determining the most efficient balance between the building and mechanical systems.

c. Certain energy saving techniques benefit the operation and maintenance of Arts and Crafts Centers. Stepping down excessively high requirements for heating, cooling, lighting, can make a considerable difference. Night time control settings and automatic regulation of mechanical equipment can also result in great savings. Lighting intensities should conform to the minimum levels recommended by the latest edition of *Illuminating Engineering Society Lighting Handbook*. Where practical, lighting should be designed for specific local tasks instead of providing uniform general loads.

d. The upper chart on this page shows the proportion of typical annual energy consumption for an arts and crafts center. The second chart shows a possible 40% savings in total consumption due to various conservation techniques, resulting in a reapportionment of energy consumption. Conservation techniques when used at the time of construction provide a real savings during the life of the facility in both resources and operating funds.

2-12 Minimizing Maintenance and Vandalism

a. Since the Arts and Crafts Center will experience very heavy wear during its lifetime from people, materials and activities, steps should be taken to keep maintenance costs to a minimum. Care in the choice of materials should insure that the building and each of its components are durable enough to withstand hard usage and to be easily cleaned. Fume hoods, dust collectors and similar mechanical devices help offset maintenance problems and increase the lifetime of the building. Equipment specified should be that which minimizes maintenance.

b. When considering new facilities, it is very important to assure that adequate funds and personnel are available to properly maintain them. This potential problem is often overlooked.

c. Vandalism is an increasing social problem nearly everywhere, including military installations. It must be considered when designing Arts and Crafts Centers. Layout of the building, the elimination of hard to supervise areas, use of durable materials and security lighting are important in alleviating this problem.

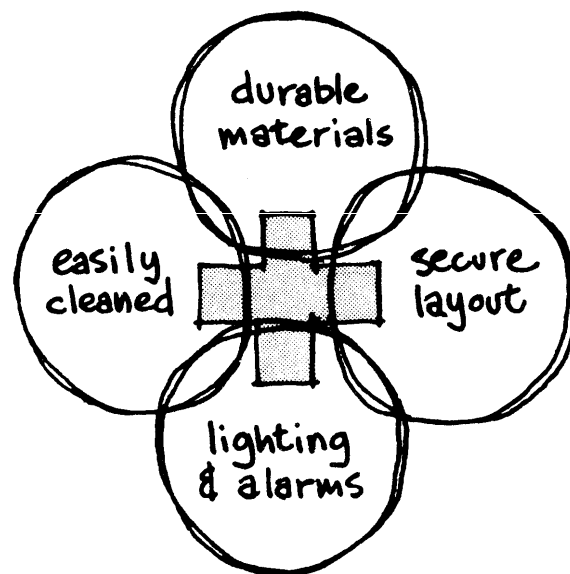

Upkeep Factors

2-13 Found Space In Existing Buildings

a. There are facilities on many installations that no longer serve their designed purposes. Finding and adapting space in such buildings to other functions may be a solution to the space needs of an Arts and Crafts Center. However, a careful analysis of functional suitability and economics is required before such a decision can be reached.

b. In order to determine the validity of using found space the planner should, in the preliminary stage, prepare an inventory of existing buildings that are available for the intended use. Any existing facility considered for long term use as an Arts and Crafts Center should, as a first principle, fit within the land-use parameters of the installation master plan. An analysis of the suitability of a particular facility for its proposed adaptive use should follow a progressively more detailed evaluation. A primary test of suitability should include:

- (1) Location and accessibility—An otherwise suitable building which is in the wrong location is not a viable solution unless other factors, such as the addition of bus service, can be introduced.
- (2) Site Size—The site must be adequate for its proposed function which may also include building additions.
- (3) Comparability of Functions—The Arts and Crafts Center must be compatible with adjacent facilities.
- (4) Availability of Utilities—An advantage of found space may be the cost savings resulting from existing utilities. Conversely, lack of basic services may be grounds for rejecting such space.

c. Facilities that appear to meet the foregoing primary test can be surveyed to determine the feasibility of converting or remodeling. The survey of an existing structure should follow an analytical format to permit value judgments of its suitability.

d. There are a number of evaluation techniques in use today. The best generally accepted methods rely on a numerical scoring system to arrive at an index of economic and functional acceptability. All methods are necessarily subjective to a greater or lesser extent, and the judgment and experience of the surveyor is an important factor.

e. The chart on page 21 illustrates one analytic format which is suitable for the level of complexity of an Arts and Crafts Center. It establishes a numerical framework within which the intrinsic value of a potential "found space" building can be approximately determined.

f. The 12 major site elements and 15 major building elements listed in column 1 are assigned a percentage of the cost for a complete building. The percentages listed

Survey and Evaluation of Existing Buildings

Survey and Evaluation of Existing Buildings			
1. SITE AND BUILDING ELEMENTS	2. PERCENTAGE VALUE OF ITEM	3. PERCENTAGE ACCEPTABLE IN THIS BUILDING	4. ACTUAL VALUE FACTOR
LOCATION SURVEY			
1 AVAILABILITY	[30]	[80]	[24.0]
2 PUBLIC TRANSPORTATION	[5]	[50]	[2.5]
3 PRIVATE TRANSPORTATION	[7]	[80]	[5.6]
4 PEDESTRIAN ACCESS	[3]	[70]	[2.1]
5 SAFETY	[5]	[60]	[3.0]
6 COMPATIBILITY	[10]	[75]	[7.5]
SUBTOTAL	[60]		[44.7]
SITE SURVEY			
7 SANITARY SEWER	[10]	[100]	[10.0]
8 ELECTRIC SERVICE	[10]	[50]	[5.0]
9 WATER SERVICE	[10]	[30]	[3.0]
10 SIZE	[5]	[50]	[2.5]
11 ROADS, WALKS, PARKING	[3]	[30]	[0.9]
12 LANDSCAPING	[2]	[10]	[0.2]
SUBTOTAL	[40]		[21.6]
TOTAL	[100]		TOTAL V.F.% [66.3]*
ARCHITECTURAL SURVEY			
1 SIZE	[5]	[80]	[4.0]
2 EXTERIOR WALLS	[8]	[70]	[5.6]
3 ROOF	[3]	[50]	[0.9]
4 FLOOR	[4]	[90]	[3.6]
5 CEILINGS	[3]	[60]	[1.8]
6 PARTITIONS	[7]	[10]	[0.7]
7 WALL FINISHES	[2]	[0]	[0]
8 FIXED EQUIPMENT	[4]	[0]	[0]
9 MISCELLANEOUS	[4]	[0]	[0]
SUBTOTAL	[40]		[14.6]
STRUCTURAL SURVEY			
10 EXCAVATION AND SUBSTRUCTURE (FOOTINGS)	[5]	[100]	[5.0]
11 SUPERSTRUCTURE (FRAME, COLUMNS)	[2]	[100]	[2.0]
12 HORIZONTAL FRAME (JOISTS, BEAMS, SLABS)	[18]	[90]	[16.2]
SUBTOTAL	[25]		[23.2]
ENVIRONMENTAL SYSTEMS SURVEY			
13 HEATING, VENTILATING, AND AIR-CONDITIONING	[20]	[50]	[10.0]
14 PLUMBING	[5]	[75]	[3.8]
15 ELECTRICAL	[10]	[65]	[6.5]
SUBTOTAL	[35]		[20.3]
TOTAL	[100]		TOTAL V.F.% [60.1]*

* See paragraph 2-13.h

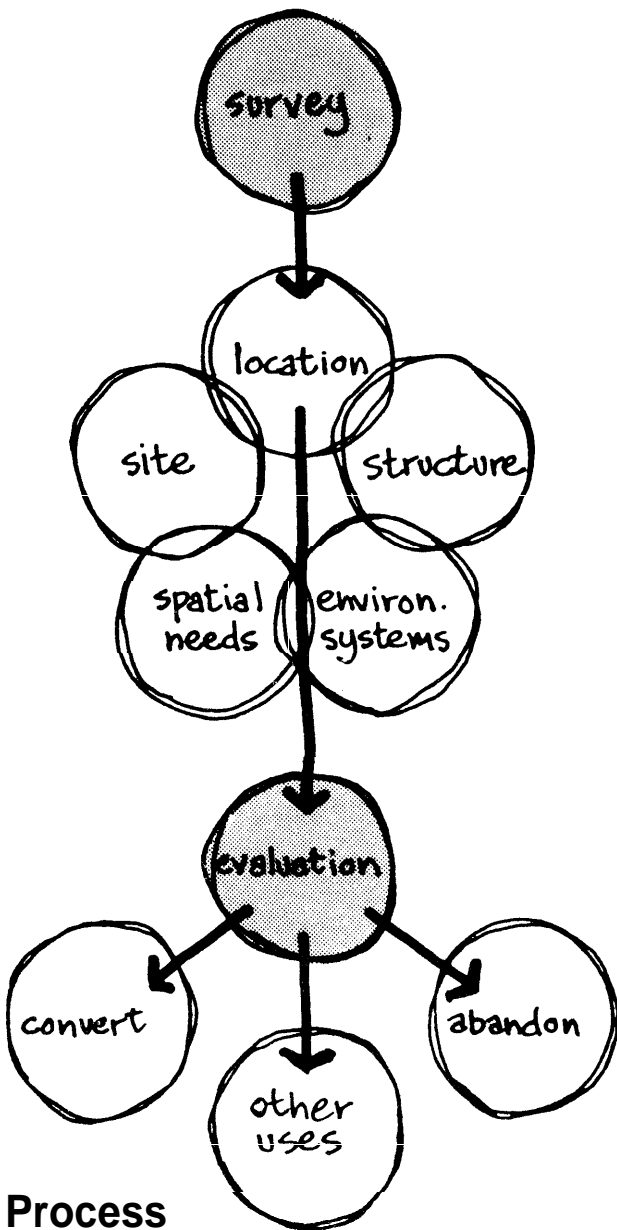

are typical and taken from construction cost indices. They may vary depending on local or special factors.

g. In most cases, a visual inspection by a knowledgeable surveyor, can result in a numerical value being assigned to the percentage acceptable for each element. Those elements that are entirely acceptable are assigned a value, or "feasibility factor" of 100. Those that require modifications are given lower numbers as are judged appropriate. These are entered in column 3.

h. Column 4 provides an "Actual Value Factor". It is determined by multiplying columns 2 and 3, and dividing by 100. The total of all actual value factors produces an overall value factor which offers a useful yardstick in approximating the relative worth of an existing facility compared to a new structure. One rule of thumb is that if the overall value factor is over 50% it would be reasonable to pursue in greater detail the economic feasibility of converting its space. Simplified, that means the existing facility in its present state is worth half that of a new physical facility. A sample evaluation is shown on the chart.

i. If the proposed facility has passed this test of acceptability, the next step is to establish preliminary cost estimates for bringing the building to a state of usefulness for its new function. This usually requires the preparation of conceptual design drawings and an analysis of the usefulness of the converted space.

j. Found space is frequently a solution to housing expanded Arts and Crafts Programs in satellite centers. For efficient space and maintenance management, a reasonably large cluster of activities should be incorporated together into one location. From the list of activities given in Chapter 3 a separation of activities into three subsections would be the maximum recommended: Woodworking Activities, Photography, and General Arts and Crafts.

k. The criteria given in Chapter 3 of this guide is based upon a 20,650 square foot Arts and Crafts Center which was selected only for illustrative purposes. Experience has shown that if a building is converted to another use, it will usually have to be larger than a building designed specifically for that use, because of inherent problems of flexibility and structural limitations. These factors must be considered when evaluating a structure for a particular use.

l. Following the preparation of a program, a conceptual design response to it, and a preliminary cost estimate, some valid judgments can be made on the advisability of converting space. Obviously, if the cost of the conversions are high in ratio to the Overall Value Factor the econom-

CHAPTER 3

Functional Space Requirements

3-1 General

a. Army arts and crafts activities are classified under basic categories. Each primary category includes a number of other activities. A minimum of the seven basic arts and crafts constitutes the essential program at Army installations. Additional activities may be added to the program as demand and resources permit.

b. This section of the guide examines the activities, participants, equipment, physical and technological requirements, space allocations and relationships for the following primary arts and crafts:

HANDCRAFTED POTTERY AND CERAMICS / glass-work, mosaics

DRAWING AND PAINTING / printmaking, serigraphy, layout and advertising design

JEWELRY AND ART METAL / enameling, lapidary, casting

WEAVING, TEXTILES AND GENERAL HAND-CRAFTS / leather, clothing and accessories

SCULPTURE AND THREE-DIMENSIONAL DESIGN / plastics, display models, interior decoration

PHOTOGRAPHY / film making, experimental processes

WOODWORK AND REPAIR / upholstery, refinishing

c. There are also support activities which generate space requirements such as lobby, lounge, exhibit areas, library, studio/classroom, office, sales area, tool issue area, storage, rest rooms, and service areas.

d. The criteria contained in this guide applies to all sizes of Arts and Crafts Centers. However, as an example a 20,650 square foot facility was chosen to illustrate this criteria. AR 28-1 states that the allocation of area within the center should conform to the following space distribution:

General Arts and Crafts	40%
Photography	10%
Woodwork and Repair	35%
Support Activities	15%

e. AR 28-1 further states that space allocation within the general arts and crafts areas (40%) will be balanced between the various activities, and if the expansion of one activity requires more than 20% of the overall space in the general arts and crafts area, it should be located in a separate specialized facility.

f. At the end of this Chapter there are two tables showing example space allocations. Example A follows the conventional pattern of separating the building into self-contained areas for each Activity listed above. Example B follows the concept of shared space which only separates incompatible or specialized activities and provides one large flexible general work area proportionately shared by each Activity.

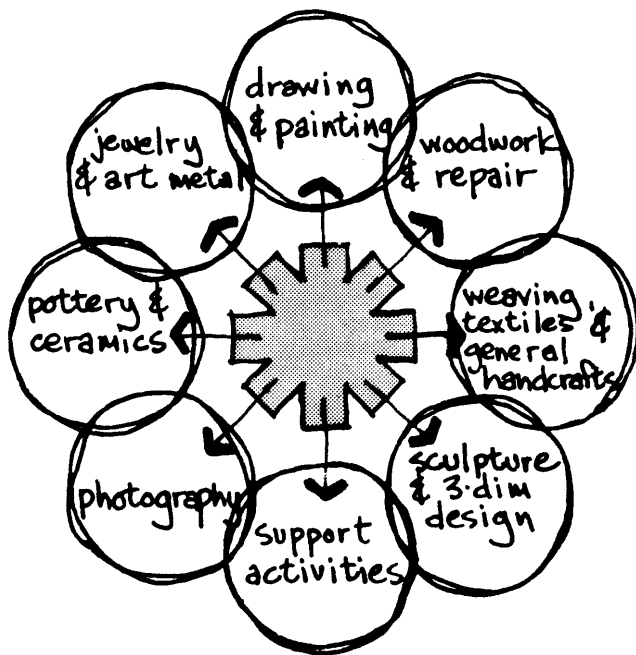

Functional Areas

3-2 Handcrafted Pottery and Ceramics

a. ACTIVITIES

(1) The process whereby earth clays and minerals are transformed into utilitarian and decorative objects is one of civilization's earliest forms of expression. Clay is worked by several methods including hand modeling, throwing on a potter's wheel, and casting. After pieces have dried, they are fired to form a bisque, glazed, and fired again. A comprehensive program includes clay preparation, forming techniques, decorating, firing procedures, and glaze formulation. The process by which a novice is familiarized with the techniques includes demonstrations, lectures, graphic presentations, and practice.

(2) Mold making is an activity related to pottery reproduction. The actual making of molds of one's own design is a creative experience. Casting of clay in ceramic molds is a repetitive process which relates more to commercial manufacturing. Such ceramic mold activities are not normally a function of the Arts and Crafts Center and if provided should be housed in a separate facility.

(3) Additional activities in the clay and mineral category involve working with glass. Mosaics, stained glass and etching, designing, forming and dumping of glass can be performed in the general arts and crafts studio as they are compatible with most other craft processes. However, glassblowing does have a considerable influence on facility design and is treated separately in this chapter.

b. PARTICIPANTS

Military personnel, dependents, retirees, and some civilian personnel will all have access to the pottery and ceramics facilities. The range of ability of the participants will be wide, and novices are usually encouraged by the more experienced. In a 20,650 square foot center, users will generally be limited to no more than 20 at one time. At least one supervisor should be present at all times.

c. PHYSICAL REQUIREMENTS

(1) Ceramic/pottery activities may be conducted within the common area of the general arts and crafts space. This includes work areas for designing, forming and glazing. However, kilns, which generate a great amount of heat, should be separated from the general work area. Working with clay can be dusty and, where possible, should be separated from other craft works. Materials often come in large containers, so storage rooms should be convenient to service entrances. Room surfaces should be nonporous and easily cleaned. Sloped floors with drains are desirable. Storage for drying of pottery is required in an area separate from the general work space.

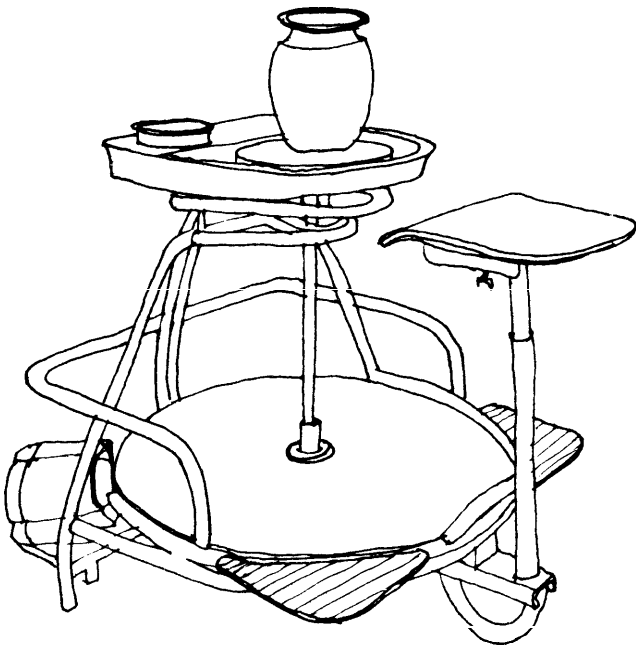

(2) Studio layout should reflect the step by step progression of the process. Correct operation of the kilns is crucial and should be under the visual control of a supervisor. Electric kilns generate a low amount of heat and may be used for bisque and low fire glazing; they are the most commonly used type at Arts and Crafts Centers. Gas kilns are high-heat units used for high fire and are in demand where more sophisticated programs are offered.

(3) Outside covered work space is desirable in moderate climates. This is especially true for high-heat generating kilns which can be built outdoors.

d. RECOMMENDED SPACE ALLOCATIONS

For a center of 20,650 square feet, approximately 1,600 square feet should be allocated to ceramics/pottery.

Work Area	1,000 square feet
Kiln Room	200 square feet
Storage	200 square feet
Covered Exterior Work Area	200 square feet*

*Amount indicates half of actual exterior area provided since covered exterior work area is programmed as half of interior building space.

e. RELATED AREAS

The office and tool issue room should be nearby. Clay storage should be near a service entrance, Kilns and glassblowing furnaces are compatible and can be isolated together, preferably on exterior walls or outdoors where climate permits.

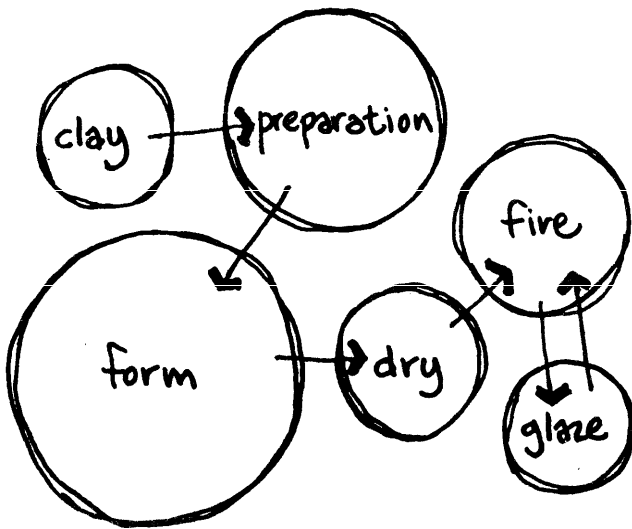

Process

f. FURNISHINGS - EQUIPMENT

Major items of equipment include: wedging boards, kiln carts, electric ceramic kilns, gas ceramic kiln, enamel kilns, portable clay storage cabinets, dampproof cabinets, drying cabinets, potter's wheels, work tables with metal tops, sinks, and spray booths.

g. TECHNOLOGICAL REQUIREMENTS

(1) A mechanical exhaust system with hoods must be provided over the kilns. If air conditioning is used in work areas, the kilns should be isolated and exhausted separately to minimize cooling demand.

(2) A dust removal system is desirable in the clay preparation area.

(3) Gas supply is required for gas kilns and 220-240 volt electric feeds for other ceramic kilns. Many enameling kilns operate on 110-120 volt current, as do potter's wheels, and other portable equipment. Outlets should be available at work tables. Lighting in work areas should be even and meet normal office space requirements.

(4) Work sinks must have sediment traps. Floor drains for washdown are desirable.

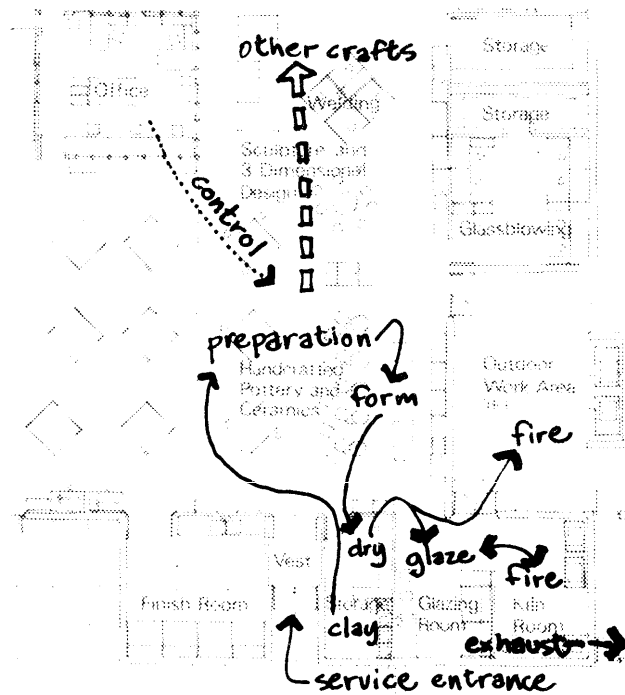

3-3 Glassblowing

a. ACTIVITIES

The popularity of glassblowing has grown rapidly, and there is an increasing demand for facilities and programs for free blowing in Arts and Crafts Centers. Although it is actually a part of Handcrafted Pottery and Ceramics, glassblowing is treated separately since it is so specialized and has its own specific physical and technological requirements. The basic process starts with the production of molten glass within a refractory container in a furnace. Molten glass can be made either by melting glass or by fusing together the raw materials that form glass. The molten glass is then gathered on the tip of a hollow-iron blowpipe and is inflated, spun, tooled, sheared and manipulated to the desired shape. The glass on the end of the tube is maintained in a molten state by a small furnace called a "Glory Hole". The glass is finally tempered in an annealing oven.

b. PARTICIPANTS

Only a small number, less than 10, can participate at any one time in the space normally allocated in a 20,650 square foot center. At least one supervisor should be present at all times.

c. PHYSICAL REQUIREMENTS

Glassblowing produces a great amount of heat, requires a generous amount of space per participant, and therefore is an incompatible activity to include in the general arts and crafts area. More suitably it belongs in a covered outdoor space or in a well ventilated foundry-type room. If indoors, furnaces should be near an exterior wall and have mechanical exhaust systems. Concrete floors, masonry walls and exposed ceiling construction are all appropriate. Storage is required for materials and tools.

d. RECOMMENDED SPACE ALLOCATIONS

For a center of 20,650 square feet, approximately 600 square feet should be allocated to glassblowing.

Work Area	400 square feet
Storage Area	100 square feet
Covered Exterior Work Area	100 square feet*

*Amount indicates half of actual exterior area provided since covered exterior work area is programmed as half of interior building space.



e. RELATED AREAS

Outdoor work areas for gas kilns. Storage Areas.

f. FURNISHINGS-EQUIPMENT

The prime equipment items are the melting or pot furnace, "Glory Hole" furnaces, and annealing oven. Craftsmen work at special benches with arms for rolling the blowpipes. A marver where glass is chilled and molded is essential. A portable yoke is provided at the entrance to the "Glory Hole" furnace. Water buckets placed on the floor are required to clean blowpipes. Small drop-off

boxes catch pieces knocked from blowpipes. A heavy-duty work counter with asbestos top should be provided. Storage shelves or cabinets for annealed products, materials and tools are required.

g. TECHNOLOGICAL REQUIREMENTS

Gas supply is required for furnaces and ovens. Annealing ovens require 208 single or three phase, or 277 single or 480 three phase volt connections or gas. Glassblowing produces great heat which necessitates a large amount of ventilation, natural or mechanical, to keep work areas bearable. All furnaces require exhaust hoods.

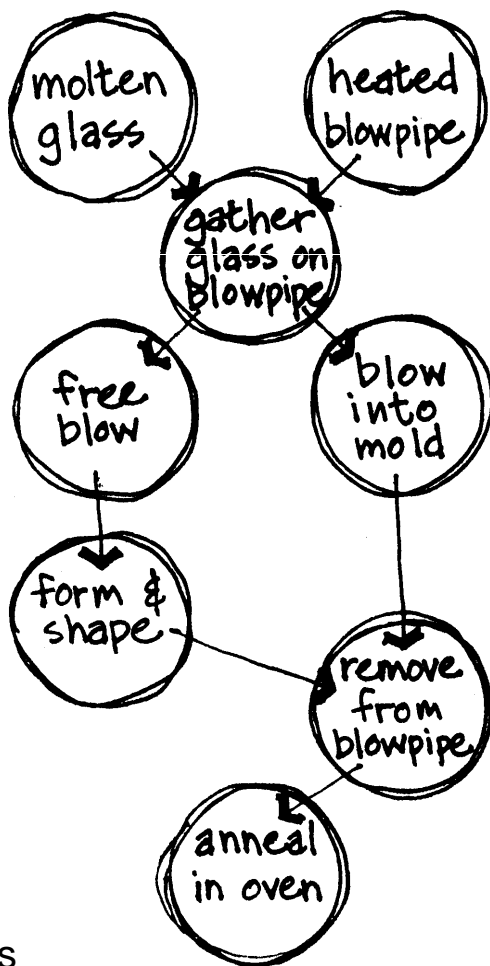

Process

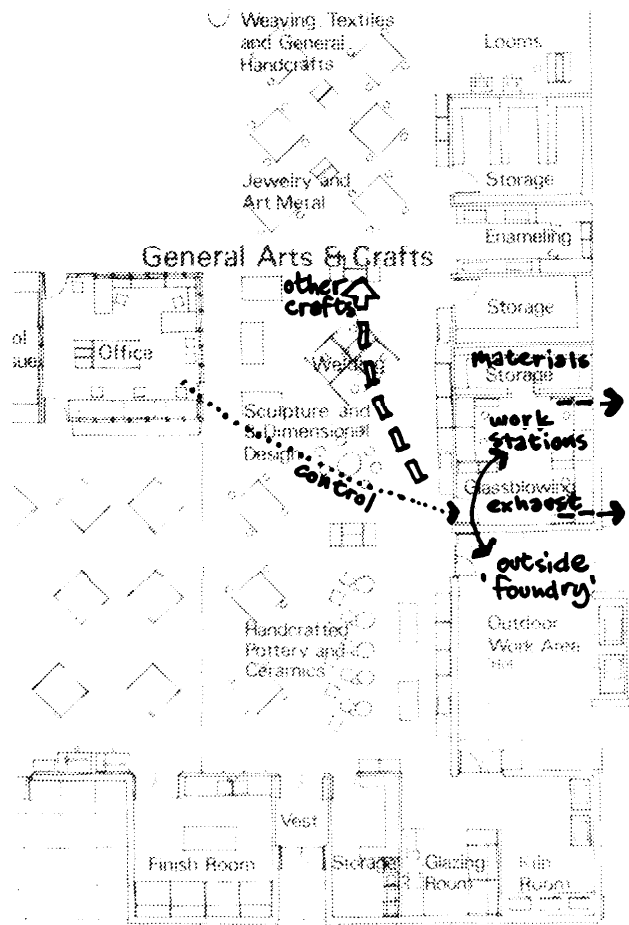

3-4 Drawing and Painting

a. ACTIVITIES

In addition to painting and drawing in a variety of media, the graphic arts program includes design projects, drafting, wood and linoleum block printing, etching, lithography, and silkscreen painting.

b. PARTICIPANTS

If properly scheduled, as many as 40 to 50 users with one or two staff members can be accommodated at one time in the space normally allocated in a 20,650 square foot center.

c. PHYSICAL REQUIREMENTS

The general area used for graphics can be typical studio space. Painted block or panel walls and acoustic ceilings are adequate. Surfaces should be washable. Acid-resistant, impervious floors such as treated concrete or quarry tile are very desirable in graphic arts areas. However, since the area serves several arts and crafts, it may be necessary to compromise on floor covering and use high quality resilient flooring throughout. Natural north light is desirable for painting and drawing areas, as is convenient access to an outdoor painting court. Toxic chemicals are used in etching and silkscreen processes and for safety they should be used away from other activities. An outdoor area for cleaning silkscreens or an acid room is desirable. Storage may be required in a general storage area with secure provisions for acid storage

d. RECOMMENDED SPACE ALLOCATIONS

For a center of 20,650 square feet, approximately 1,760 square feet should be allocated to drawing and painting.

General Work Area	1,200 square feet
Acid Room	60 square feet
Storage Room	300 square feet
Covered Exterior Work Area	200 square feet*

*Amount indicates half of actual exterior area provided since covered exterior work area is programmed as half of interior building space.

e. RELATED AREAS

Office
Photography
Exterior Work Areas
Studio/Classroom/Gallery

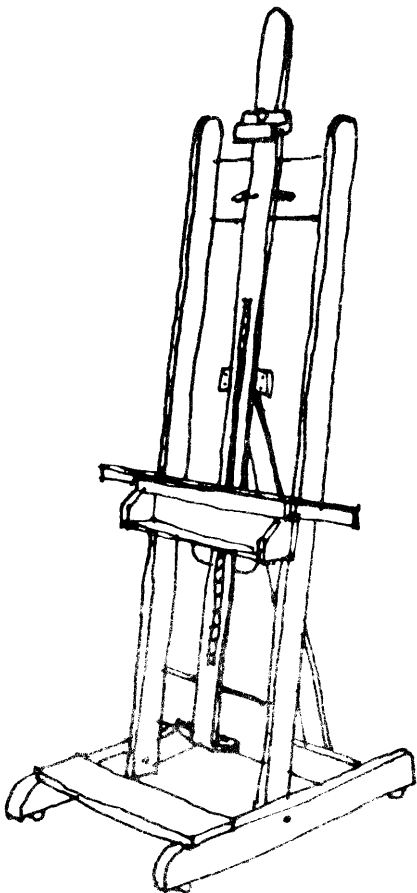

f. FURNISHINGS – EQUIPMENT

Major items of equipment include, printing presses, block printing presses, drawing tables, paper cutters, easels, paper storage cabinets, chairs and stools, display cases, work tables with surfaces for cutting, drying racks for prints, slatted storage for canvases, a slide projector with screen, portable easels, and work sinks.

g. TECHNOLOGICAL REQUIREMENTS

In the general work area, heating, ventilating, and air conditioning requirements are unchanged for typical arts and crafts spaces. Electric lighting should duplicate as much as possible daylight qualities for painting and drawing. In toxic chemical areas, sinks and traps must be acid resistant. Sewage treatment facilities may not accept acids, and in these instances provisions must be made for their storage and proper disposal. If acids are heavily used, special air exhausts are required. An emergency eye wash and shower must be provided.

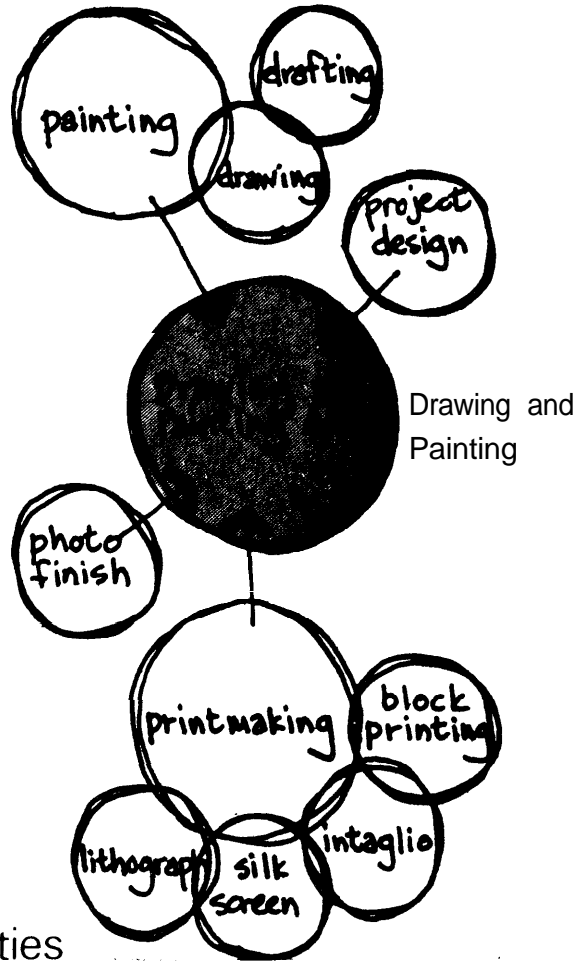

Activities

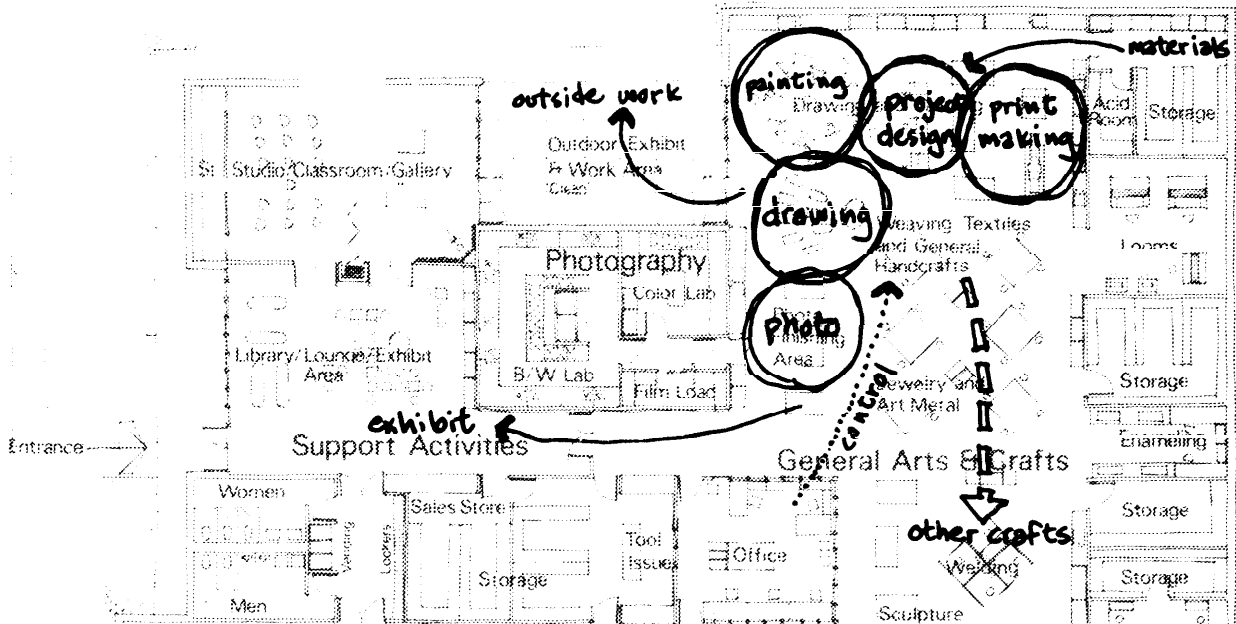

3-5 Jewelry and Art Metal

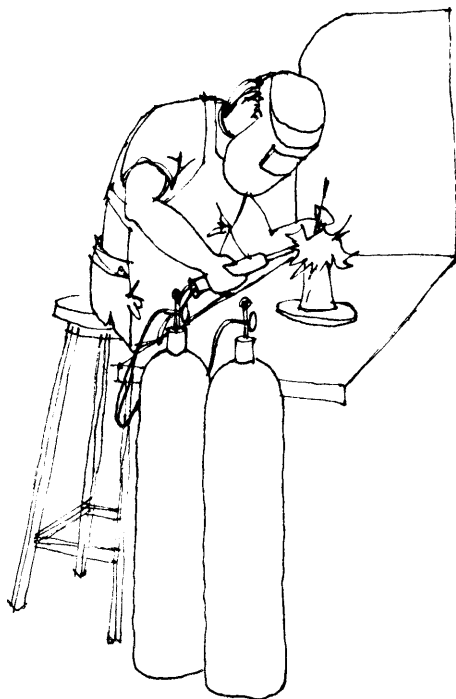

a. ACTIVITIES

A knowledge of the properties of metals is basic to activities in the program. Processes include designing and construction with sheets, wires and tubes and soldering, welding and casting. Projects include various forms of jewelry, ornaments, hollow ware, welded metal sculpture and utensils executed in copper, bronze, silver, pewter, tin, lead and gold. Hand and power tools are used in the various processes. Design and construction of jewelry may require the addition of stone settings and coloring. Additional activities in this category include procedures for lapidary (cutting or polishing stones) and metal enameling (fusing color to metal in a kiln).

b. PARTICIPANTS

Fifteen to twenty participants can be accommodated at any one time sharing other activities with two staff members within the space allocated in a 20,650 square foot center.

c. PHYSICAL REQUIREMENTS

This program takes place within the general arts and crafts area. While the characteristics of the multi-purpose space are suitable for many activities in jewelry and art metal, there are some cautions that should be exercised in planning, depending on the extent of the program. For instance, welding and hot-metal casting should be set aside in an alcove with a hardened concrete floor. Acetylene torches should have a shielded work space with good mechanical ventilation. Special gas jets may be installed over work tables for fine soldering. Enameling involves the use of acids, kilns and blowtorches; therefore, the area where enamel is applied and dried should be apart from other areas to prevent spreading metal dust or jarring enamels that are drying. The dust from clay in the ceramics area is incompatible with the enameling process, and these two functions should be separated.

d. RECOMMENDED SPACE ALLOCATIONS

For a center of 20,650 square feet, approximately 1,200 square feet should be allocated to jewelry and art metal.

Work Area	800 square feet
Storage Area	200 square feet
Enameling Room	200 square feet

e. RELATED AREAS

Office
Other General Arts and Crafts

f. FURNISHINGS – EQUIPMENT

Much of the jewelry work can be done at standard work counters with accessory V-blocks, anvils, gas fixtures and vises attached. Alternatively, two to four jeweler's workbenches can be provided in the general work space. At least one asbestos-covered work top is needed, Hot metal casting requires furnaces which should be vented. Slab saws and flat laps are floor mounted items. Combination lapidary units can perform several operations but limit the number of active participants. Therefore in a large shop, separate lapidary units for cutting, grinding, polishing and buffing are preferable. Water connections are required for some grinders. Buffing machines, drill presses, trim saws, centrifugal and vacuum casting machines, faceting machine, grinding arbors, burn out kilns, sanders and gem tumblers can all be bench mounted. Lapidary equipment should be so placed as to facilitate the progression of operations from dabbing, trimming and grinding through polishing and faceting.

g. TECHNOLOGICAL REQUIREMENTS

Grinding arbors and grinding/polishing units require pressure water connections which is preferable to a siphon water system. A sediment sink is necessary for washing stones and castings, mixing casting investment and cleaning metals. Toxic chemicals must be disposed through acid-resistant sinks and piping. Exhausts are required for hot metal casting equipment, ovens, torches, and spray booths. Some electric kilns and lapidary equipment may require 220 volts but most jewelry equipment requires 110 volts. Supplies of oxygen, gas and compressed air are required. In addition to normal lighting levels, concentrated local lighting is required for delicate tasks.

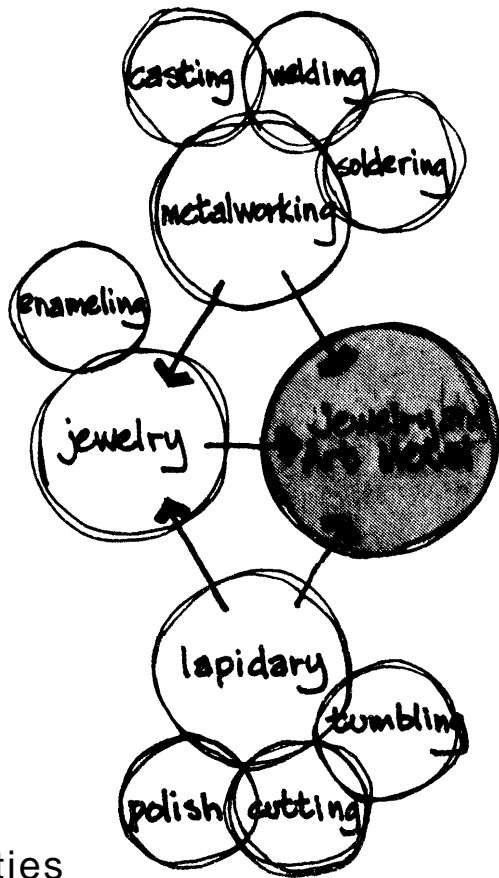

Activities

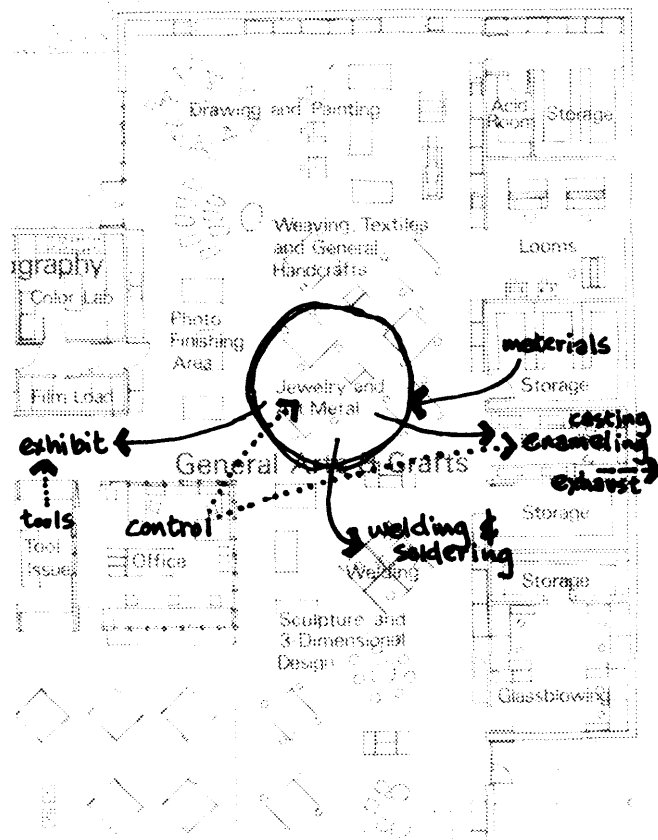

3-6 Weaving, Textiles and General Handicrafts

a. ACTIVITIES

This program covers a wide variety of activities. Loom weaving, tapestry work, batik, tie-dye, macrame, soft sculpture, banners, fabric collages, needlepoint, stitchery, and sewing are all part of this general category. In addition, leather craft, with its braiding, lacing, sewing and tooling, and other general crafts such as bookbinding, basketry, candle making and puppetry fall within the general handicrafts nomenclature.

b. PARTICIPANTS

A 20,650 square foot center would normally provide space for approximately 40 participants and two staff members to use the facilities at any one time.

c. PHYSICAL REQUIREMENTS

The general work area should be flexible to allow for frequently changing needs. Some activities will require a permanent setup, such as floor looms and sewing machines, and these may be installed in alcoves. The predominant arrangement, however, will be one of movable work tables and counters which can be adapted for a variety of crafts. Storage should be provided within a common room.

d. RECOMMENDED SPACE ALLOCATIONS

For a center of 20,650 square feet, approximately 1,700 square feet should be allocated to weaving, textiles and general handicrafts.

Work Area	1,000 square feet
Weaving Area	400 square feet
Storage Area	300 square feet

e. RELATED AREAS

Office
Library/Lounge/Exhibit Area
Studio/Classroom/Gallery

f. FURNISHINGS - EQUIPMENT

The basic furnishings consist of workbenches, tables, and stools. Much of the specialized equipment is portable. Foot powered looms occupy considerable floor space when in operation but may be moved together and stored when not in use. Table looms, rug looms, and tapestry frames can be utilized on table tops and stored when not

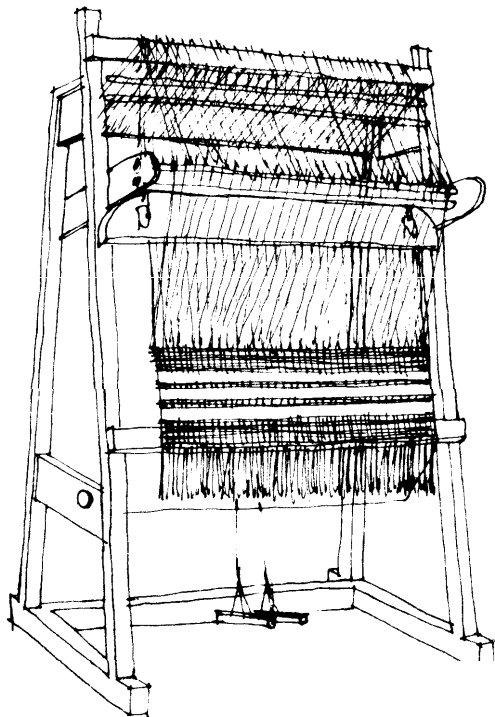

in use. Heavy-duty sewing machines are essential in a textile program. Enamel pans, hot plates and drying racks are necessary for dyeing.

g. TECHNOLOGICAL REQUIREMENTS

There are no unusual requirements for heating, cooling and ventilating. Service sinks should be provided. Gas and compressed air should be available in the general work space for other nontextile handicrafts. 110 volt service and an overall lighting level of 70 footcandles is adequate. Some direct lighting on sewing machines and looms where close work is necessary may be required.

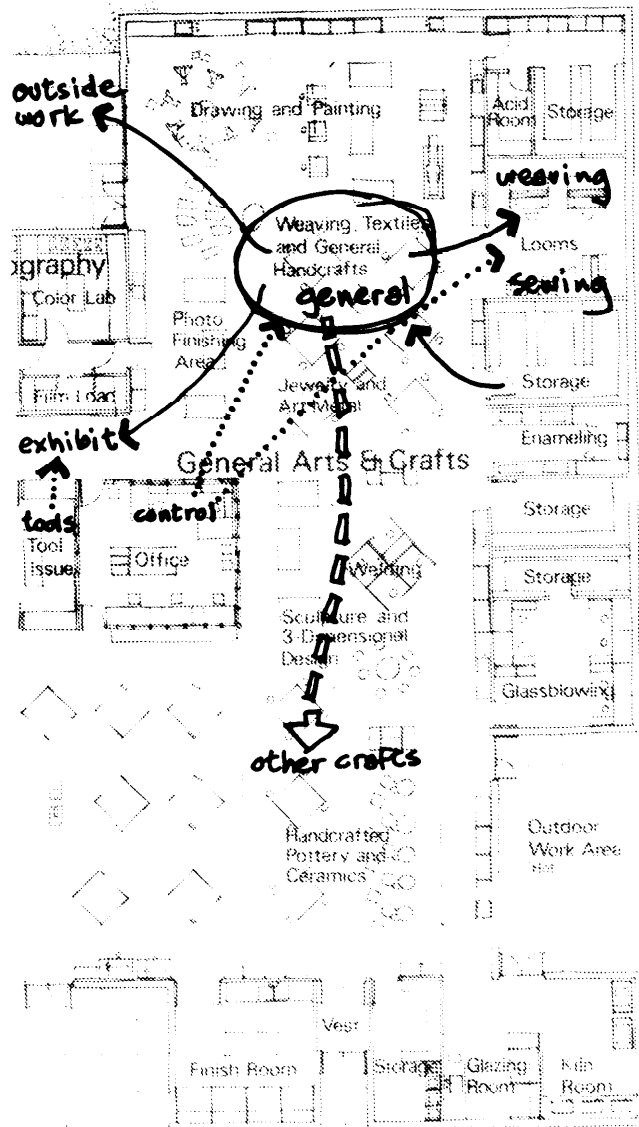
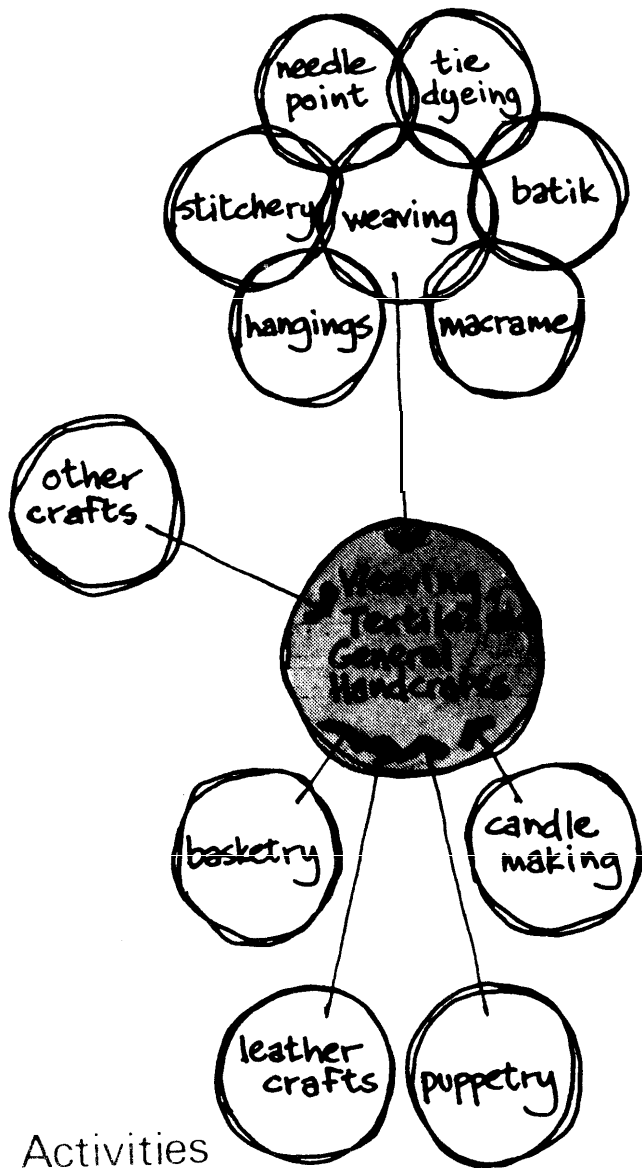

Activities

3-7 Sculpture and Three-Dimensional Design

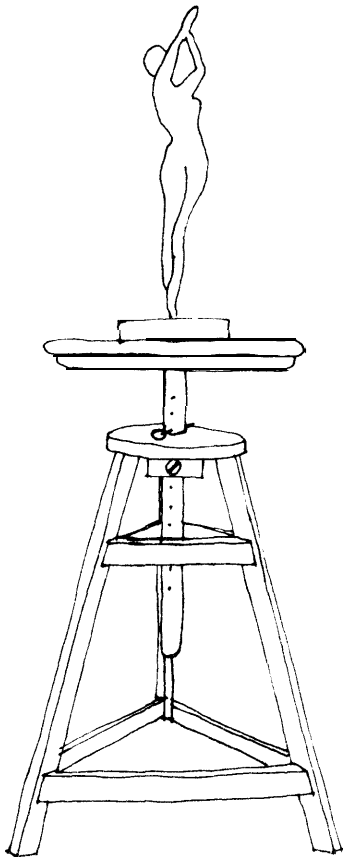

a. ACTIVITIES

This branch of the program covers the use of materials and techniques to produce three-dimensional objects, figures, or construction in the round or half round. Processes in sculpture involve clay modeling, wood carving, stone cutting, plastic work, metal casting and welding. Model building, paper mache work, displays and exhibition properties and interior decoration are additional activities within this category.

b. PARTICIPANTS

This activity interests people of all ages, and a wide variety of participants might be expected. The number of persons actively working on projects may be as many as 20, with even more participating in classes. Some processes, particularly casting and foundry work, require the combined efforts of two or more persons. One or two staff members should be present for supervision.

c. PHYSICAL REQUIREMENTS

Many activities will take place in the general arts and crafts area without special modifications. Projects such as clay sculpture, welding, or woodcarving can utilize the same areas provided for pottery, art metal, woodwork, and outdoor projects. Large exhibition work requires unobstructed space.

d. RECOMMENDED SPACE ALLOCATIONS

For a center of 20,650 square feet, approximately 1,400 square feet should be allocated to sculpture and three-dimensional design.

Work Area	1,000 square feet
Storage Area	200 square feet
Covered Exterior Work Area	200 square feet*

*Amount Indicates half of actual exterior area provided since covered exterior work area is programmed as half of interior building space.

e. RELATED AREAS

Office
Studio/Classroom/Gallery
Handcrafted Pottery and Ceramics
Jewelry and Art Metal
Woodwork and Repair
Drawing and Painting
Exterior Work Areas

Activities

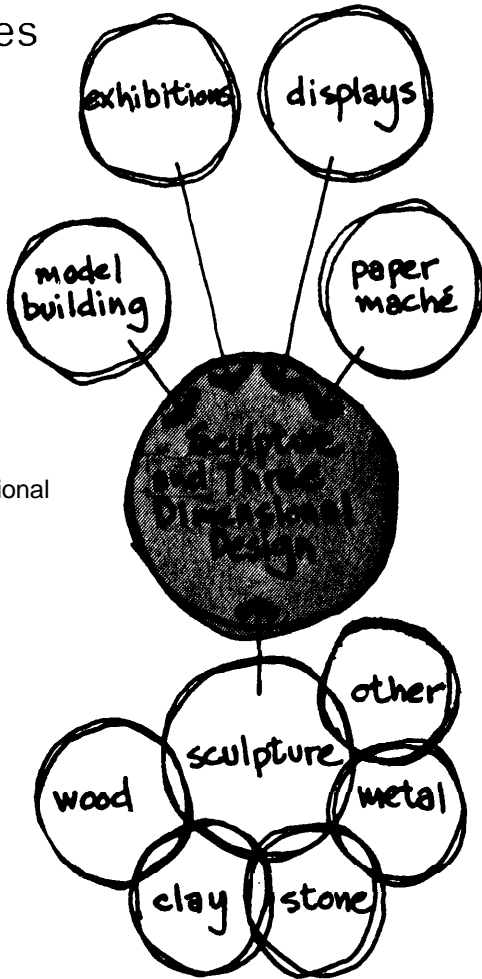

Sculpture and Three Dimensional Design

f. FURNISHINGS – EQUIPMENT

Major items include floor and table sculpture stands, several sets of hand chisels, portable electric chisels, grinding and buffer arbor, welding equipment and a heavy anvil. Workbenches and stools already provided in the general arts and crafts area are adequate for most projects. Woodworking power tools, kilns and furnaces used in other activities can be shared.

g. TECHNOLOGICAL REQUIREMENTS

Special requirements for welding and heat-generating equipment has been outlined previously in Section 3-5.

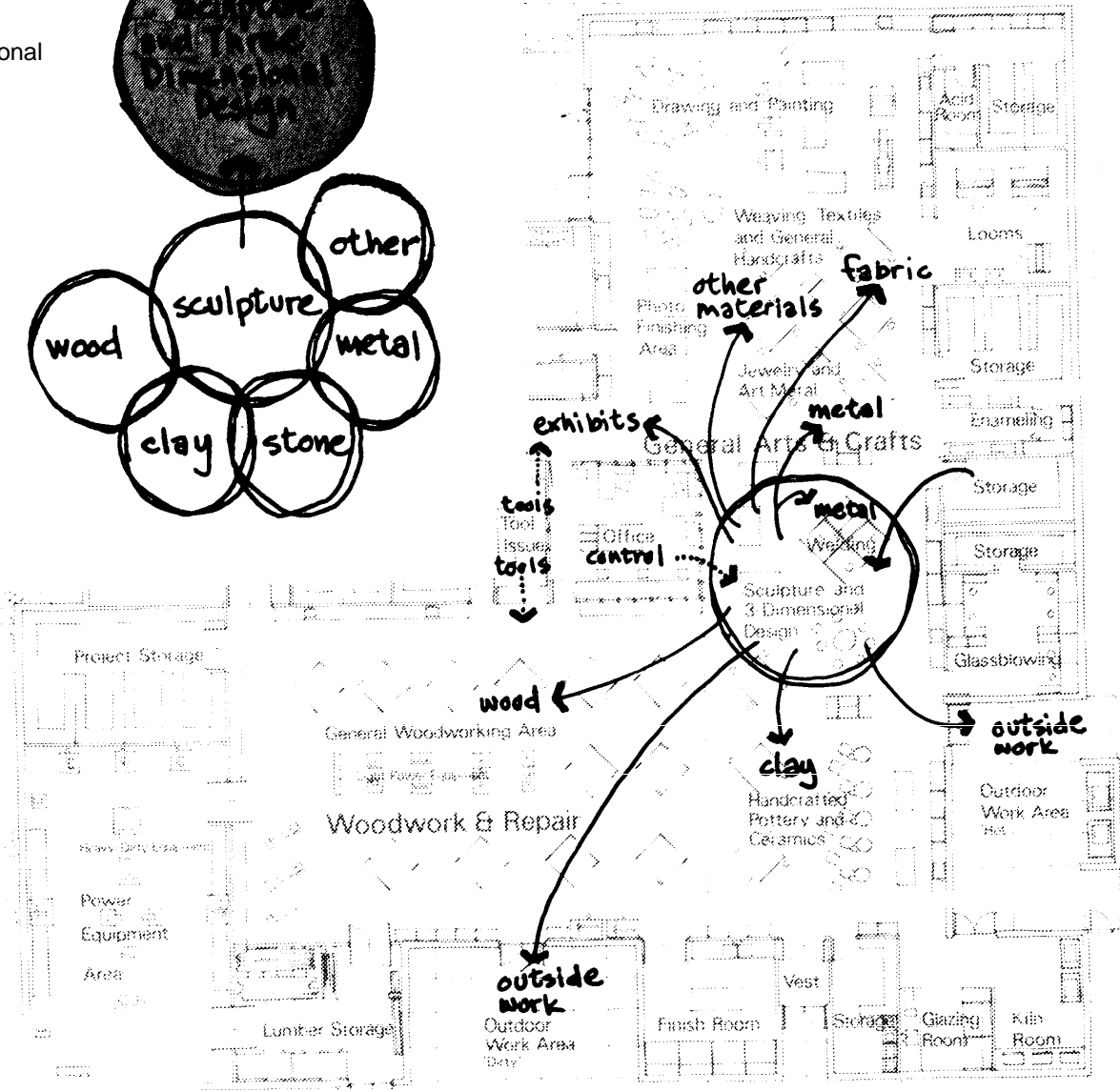

3-8 Photography

a. ACTIVITIES

(1) Basic processes of photography remain the same although there are wide differences in sophistication of equipment, techniques of still and motion pictures, and variations between monochromatic and color film. Film processing consists of loading, developing, enlarging, print washing, drying, trimming, and mounting. Other elements of the center's photography program include studio work, film and slide projection, demonstrations, classroom instruction, and exhibits.

(2) There are three basic functional areas in a photography department: the studio/classroom/gallery which may be shared with the other craft activities; the photographic laboratory where film processing takes place; and the finishing work area where prints are dried, trimmed and mounted. The photographic laboratory should be divided into two separate areas when both monochromatic and color film are processed.

b. PARTICIPANTS

Photography is one of the most popular activities in the Army arts and crafts program. This size of facility will accommodate a maximum of 50 participants at any one time: 25 users and one or two staff members in the studio/classroom/gallery with a similar number in the laboratory and finishing area.

c. PHYSICAL REQUIREMENTS

(1) The studio/classroom/gallery is a multi-use area that should be designed with flexibility in mind. For use as a portrait studio, it should have effective light control at windows to bar extraneous light. An adjacent closet for storing chairs, props and equipment is desirable, as is a pull-down screen for projection. When used as a gallery, continuous wall tracks and wall systems for hanging displays reduce special exhibit requirements and simplify hanging backdrops for portrait use. A chalkboard should be included for instruction. A folding partition adds to the flexible use of this space. Ceilings should be designed to allow for spotlights to be attached for illuminating exhibits.

(2) The photo lab encompasses all activities of film processing. It starts with film loading which takes place in totally dark cubicles. The monochromatic film processing darkroom is used with safe lights, but conventional color film processing requires a separate darkroom with total darkness. However, recent advances in color films will undoubtedly reduce light safeguard requirements. A red glass

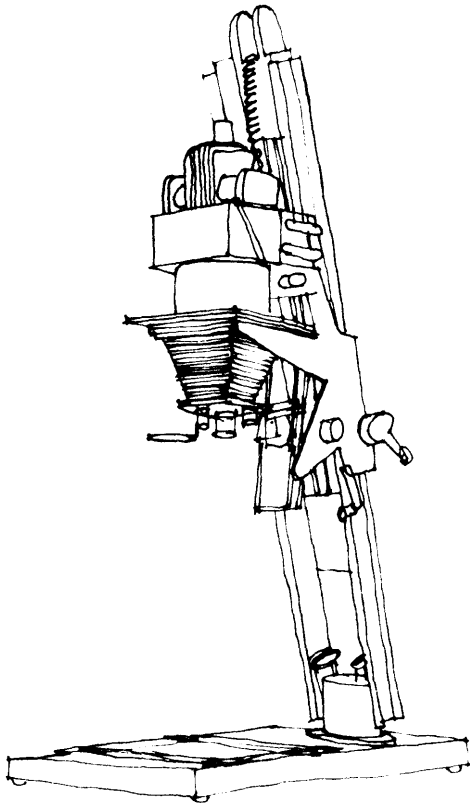

Process

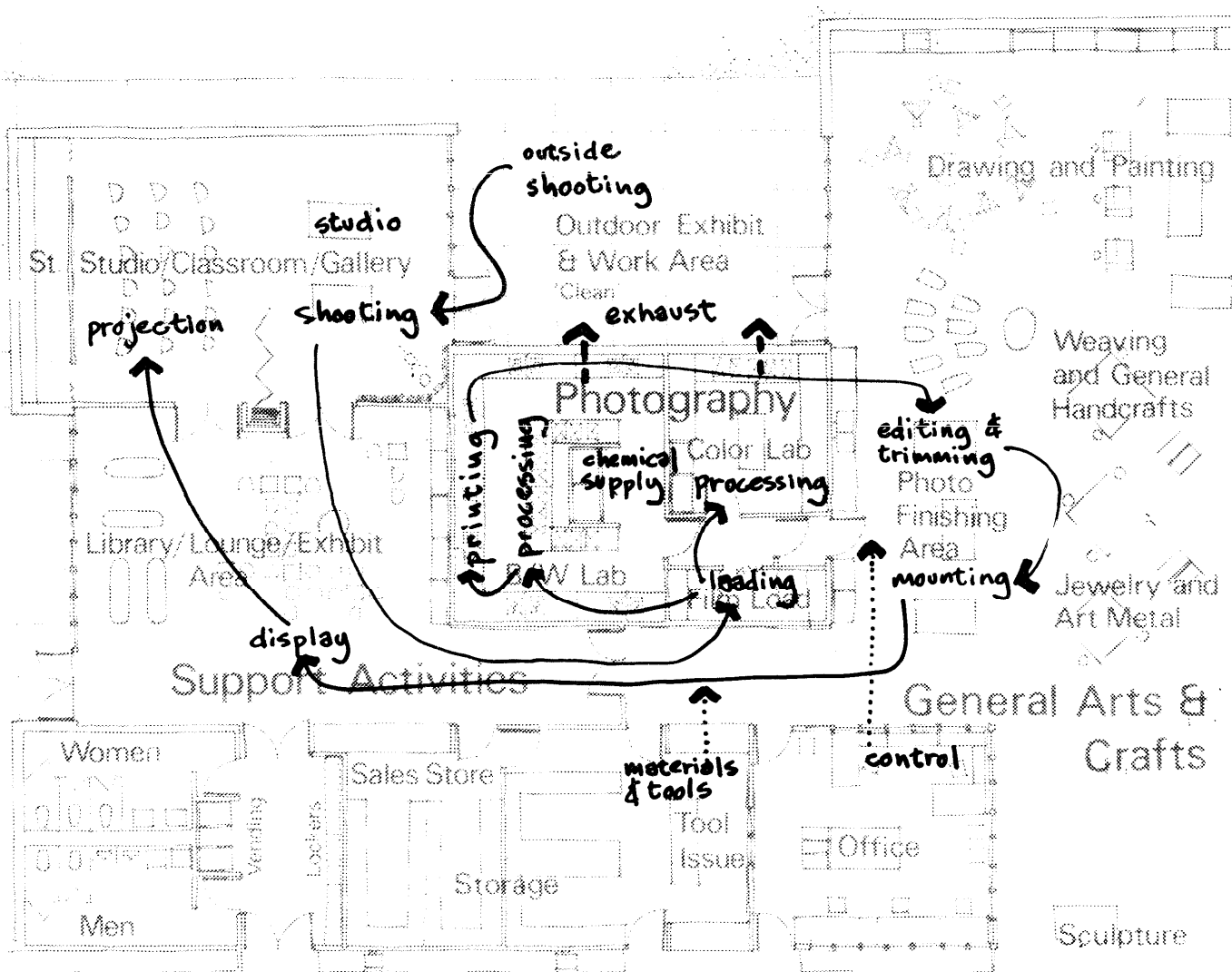
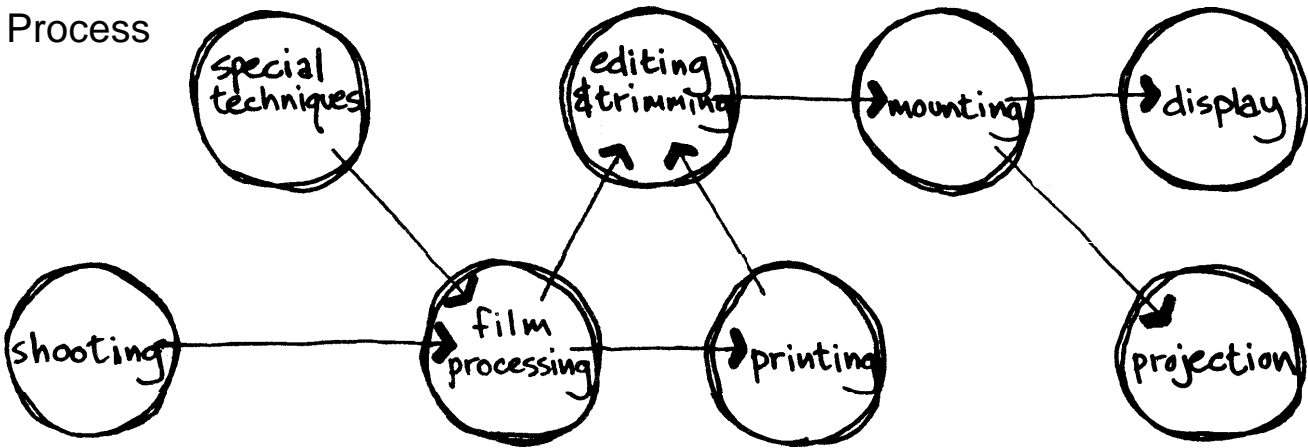

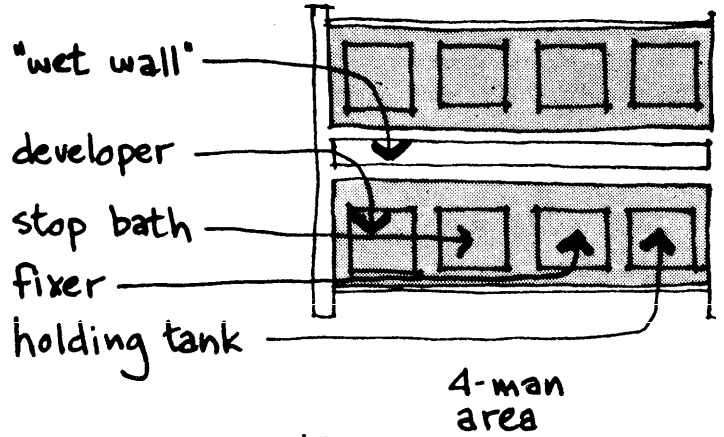
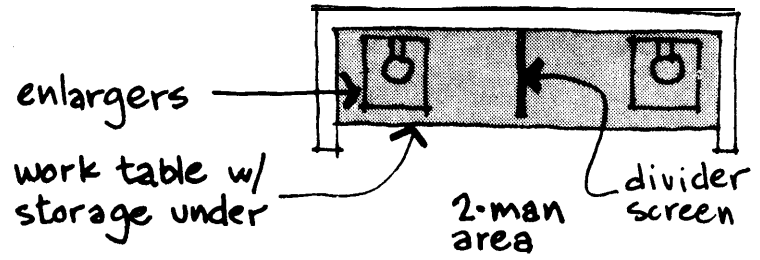

Optional 2-4 Man Work Areas

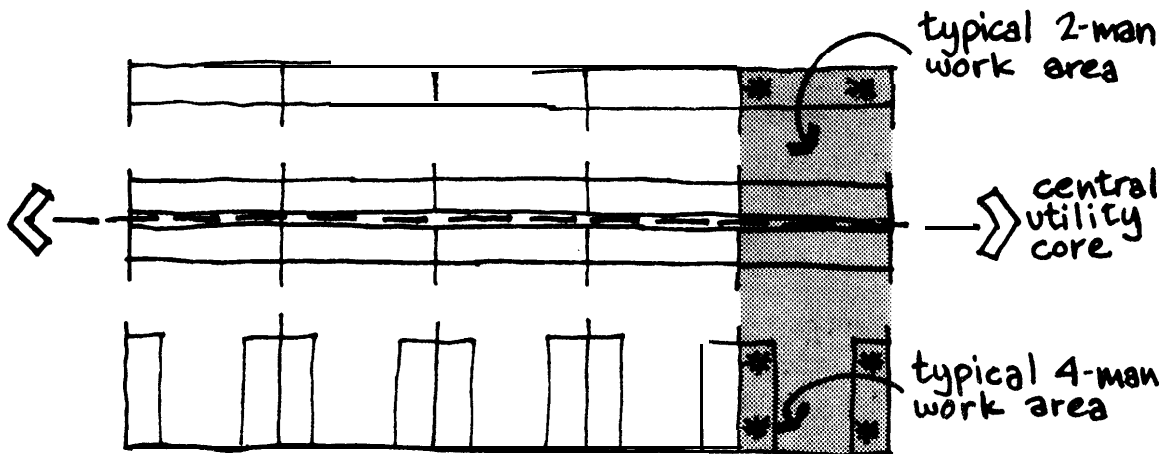
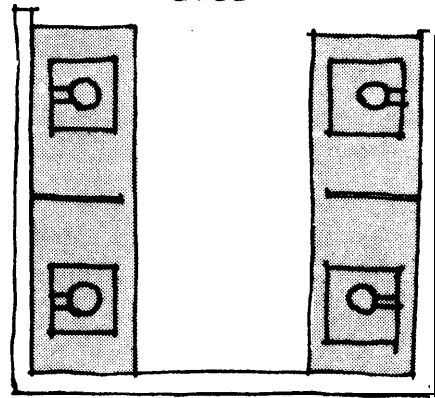

partition (red plastic over glass) has been successful in some photo lab work areas. Dark rooms require light-trap entrances. Room surfaces in the processing area should be nonporous, easily cleaned and chemical resistant.

(3) The finishing work area need not be a particularly specialized space. There are no special lighting or isolation requirements. In fact, except for the storage of some special equipment, there is no real impediment to using shared space for this activity. In particular, it relates closely to the graphic arts.

(4) In larger photo facilities, thought should be given to providing separate space for a staff office and a central storage room.

(5) Physical arrangements can be varied from the large general dark rooms to smaller activity centers with work areas for two to four people. Various options are illustrated on page 40.

d. RECOMMENDED SPACE ALLOCATIONS

(1) For an Arts and Crafts Center of 20,650 square feet an area of approximately 2,065 square feet is recommended.

(2) The following suggested breakdown assigns space to general functional areas without endorsing any particular layout:

Monochromatic Processing Lab	600 square feet
Color Processing Lab	200 square feet
Film Loading Room	65 square feet
Finishing Area	400 square feet
Storage Area	100 square feet
Studio/Classroom/Gallery	500 square feet* *
Covered Exterior Work Area	200 square feet*

*Amount indicates half of actual exterior area provided since covered exterior work area is programmed as half of interior building space.

** 50% of Studio/Classroom/Gallery attributable to Support activities (Paragraph 3-10).

e. RELATED SPACES

(1) The studio/classroom/gallery should be near the main entrance, library/lounge/exhibit area, and office.

(2) The finishing area should be convenient to the graphic arts area. Possibly it can be a shared area.

f. FURNISHINGS - EQUIPMENT

(1) Equipment requirements may vary depending upon

the emphasis of particular programs. The following list is general in nature:

(2) Studio/Classroom/Gallery—Backdrops, mobile rear screen projector, stacking chairs, film and slide projectors.

(3) Photo Finish Area—drymounting presses, papercutter, sink, print drying cabinets, print dryers, copy camera, work tables and counters.

(4) photo Laboratories—enlargers, refrigerator, contact printers, developing sinks, film drying cabinets, papercutter, paper cabinets, metal-lined cabinets, print washers, safe light, timers.

g. TECHNOLOGICAL REQUIREMENTS

(1) photo work is generally performed in an enclosed controlled environment. Air conditioning systems which maintain even temperature, constant relative humidities and frequent air changes are necessary. Dust elimination filters are important. Louvers should be light sealed.

(2) Hot and cold water supplies with mixing faucets and temperature controls are needed in the laboratories. In some areas special filters will be required to remove mineral deposits in the water. Sinks should be stainless steel with chemical resistant traps. Consideration must also be given for provision of an industrial waste line or holding tank for spent photographic liquids.

(3) The studio/classroom/gallery requires ceiling outlets for use of special lights. These should be controlled by rheostats. There should also be adequate outlets for photo-floodlights and projectors.

(4) Sodium vapor safe lights, which are used in monochromatic printing, are brighter and more maintenance free than other types. They may require baffles or filters. Key operated auxiliary lighting should be provided in darkrooms for cleaning purposes.

(5) In the processing room, adequate outlets are required for enlargers, timers and safe lights. Print dryers and drymounting presses should be on separate circuits. Continuous outlets mounted one foot above counter height are very desirable.

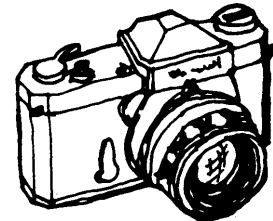

3-9 Woodwork and Repair

a. ACTIVITIES

(1) The woodworking program requires space and equipment for a variety of general carpentry and cabinetry activities. These include furniture design, construction, repair and refinishing, upholstery, turning, pattern work, picture framing and rough carpentry projects.

(2) Although the woodworking portion of the arts and crafts program includes repair of small appliances, radios, television sets and other electronic equipment, it should not be done in the woodworking area. Repairs of this nature should be done in the more dust-free areas, such as the general arts and crafts area.

b. PARTICIPANTS

Woodworking is performed primarily by career military and retired personnel. The shops are less used by dependents. Most participants work independently on projects. In a 20,650 square foot center the number of users should be limited to a maximum of 40 at any one time, for which at least three supervisory personnel should be present at all times.

c. PHYSICAL REQUIREMENTS

(1) Within the woodworking area, space must be provided for the following activities: receiving and storing lumber, using fixed-power equipment, building projects both large and small, using hand tools, finishing, hand sanding, storing projects, issuing tools, demonstrations, and controlling the operations of the shop.

(2) Shop layout will depend on the overall approach to sharing space with other activities in the center. In any case, noisy, dusty machines should be separated from the general work area. Finishing and drying requires a separate dust-free space. Where possible these activities should be in separate rooms. Consideration might be given to the use of a self-contained auto-type spray booth as a finishing room with access arranged through a vestibule serving both the shop and an outdoor work area. A small space with drawing board is desirable for project planning. The lumber storage area should be near the major fixed equipment.

(3) The plan should be based on safe functional operation of activities and flow of materials and personnel. Operational clearances required for various types of power equipment are shown on the plan on page 44.

(4) Hardened concrete floors are most common in woodworking shops. Wood floors offer a softer walking surface and better acoustics, but they have higher initial cost and

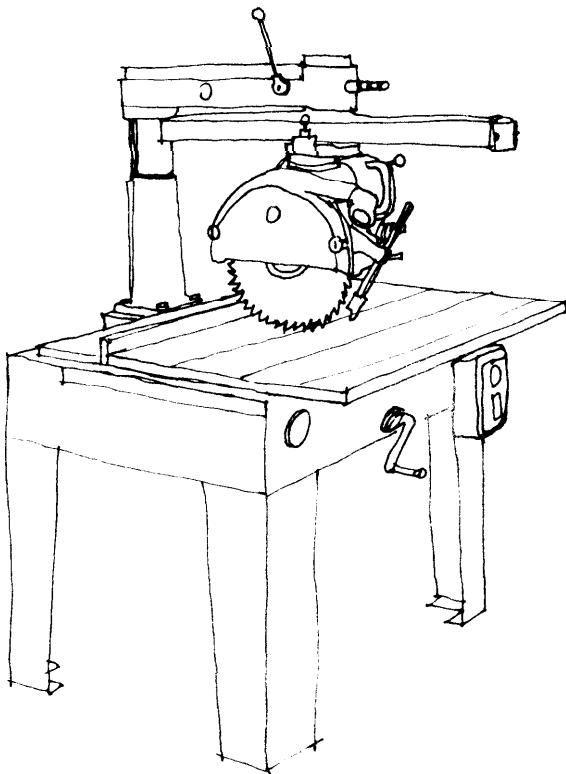

Process

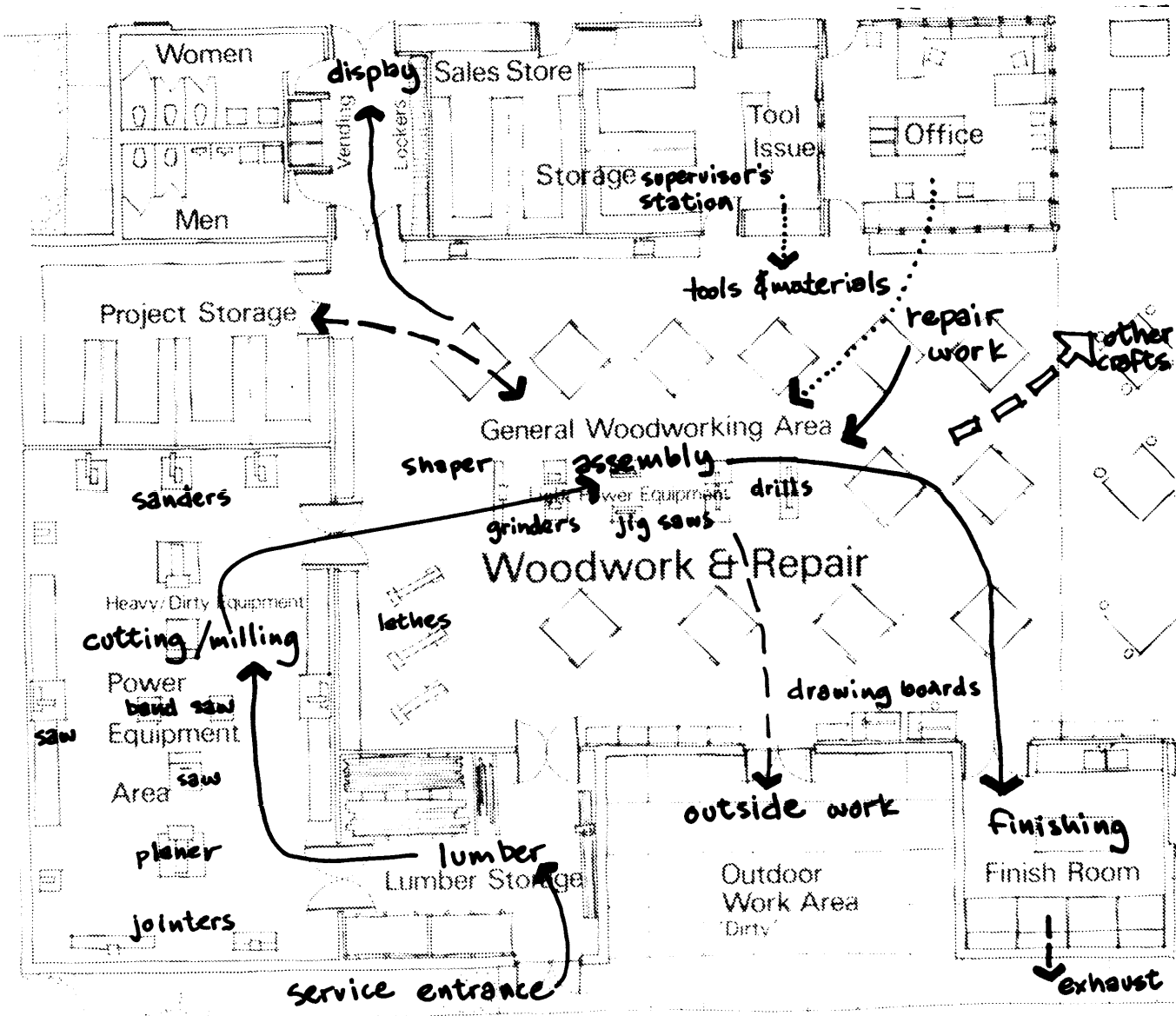
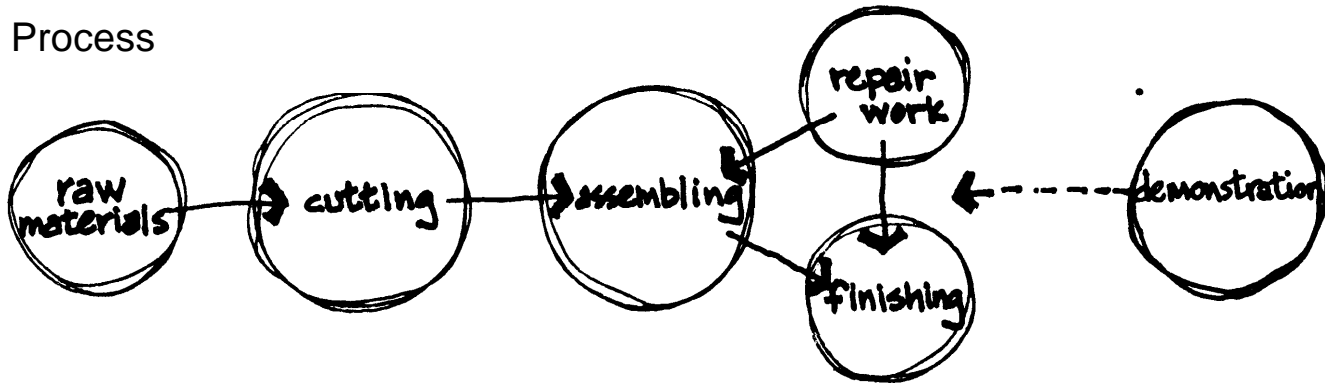

Operational Clearances

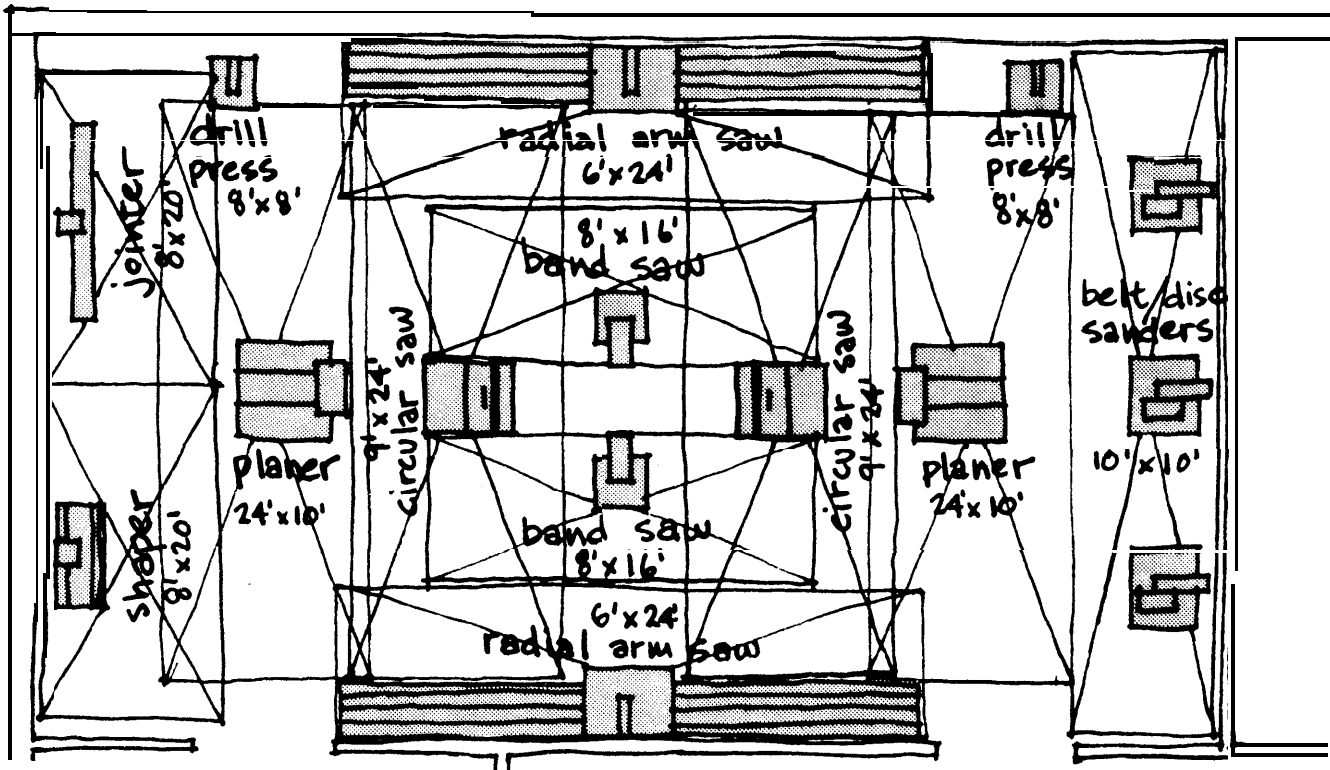

greater maintenance. Floors should be nonslip. Low windows are not desirable but windows may be provided above door head height. All glazing should be wire glass or plastic.

d. RECOMMENDED SPACE ALLOCATIONS

For a center of 20,650 square feet, approximately 7,225 square feet should be allocated for woodworking.

General Work Area	3,025 square feet
Power Equipment Area	2,000 square feet
Lumber Storage	500 square feet
Project Storage	600 square feet
Finish Room	400 square feet
Tool Issue Room and Supervisor's Station	300 square feet
Covered Exterior Work Area	400 square feet*

* Amount indicates half of actual exterior area provided since covered exterior Work area is programmed as half of interior building space.

NOTE: [For safe working conditions an allowance of 75 to 125 square feet per person is required (includ -

ing machinery) in woodworking according to type of activity in progress.]

Width/length ratio of work area:	minimum 1/1, maximum 1/2
Minimum width of general work area:	30 feet
Minimum ceiling height:	12 feet

e. RELATED SPACES

The woodworking shop should be located in an area of the building which isolates noise. A supervisor's station should be near or part of office and tool issue room. The service and material receiving entrance should be under staff supervision. Convenient access is needed to the technical reference library. Wash-up areas and lockers for work clothes should be provided near the shop entrance.

f. FURNISHINGS - EQUIPMENT

(1) The National Safety Council and Army Safety Directors urge that special precautions be taken in all woodworking areas to prevent accidents to participants. All

Shop Arrangements

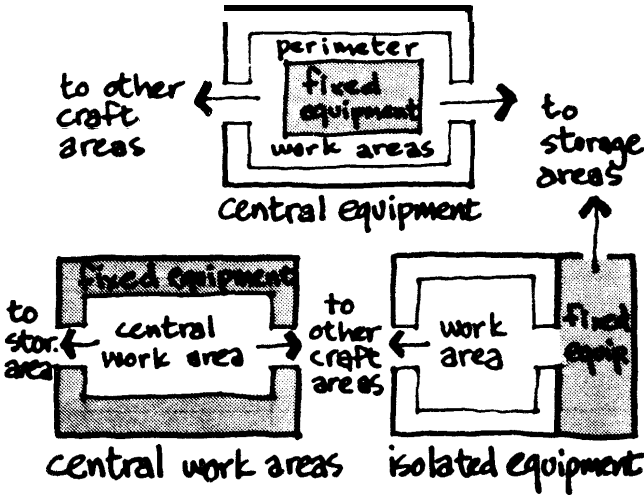

fixed power tools should be surrounded by "safety islands" marked with tape and should be separated from general circulation and arranged so that ample space is provided for the operator and task. Aisles should be generous enough to permit free two-way passage. Workbenches should be grouped and spaced according to sizes of anticipated projects. Tools and equipment should be of industrial quality. Each machine must have a guard attached and locked on and a safety cut-off switch in addition to the master switch for the area. Power tools should be grounded. Floors should have a non-slip finish. Color coding machinery will contribute to safe operations. It is recommended that the center's director and the supervisors of the woodworking activities become familiar with the safety requirements for woodworking power tools as set forth in the Occupational Safety and Health Act of 1970.

(2) The following list notes the major items of equipment which are typical for a woodworking facility of approximately 7,225 square feet: Radial arm saws, wood lathes, four-station work benches, band saws, drill presses, jig saws, circular saws, disc sanders, belt/disc sanders, jointers, shapers, panel saws, surface planers, hand tools, vises, lockers, and storage cabinets.

g. TECHNOLOGICAL REQUIREMENTS

(1) A dust removal system is an important feature for the safe operations of power equipment. This should be placed underfloor or overhead and be fitted with flexible hose connections. In new construction, the more preferred underfloor system provides a permanent, relatively quiet, obstruction free installation but it is less flexible,

more difficult to reach for maintenance and generally more expensive than an overhead system. In either case, all secondary runs must enter main ducts at acute angles, and clean out points should be provided at all angular connections. Extra hookup points should be provided for future equipment needs and for use as a built-in vacuum cleaning system. For safety, noise reduction and waste disposal, dust collection hoppers and fans should be placed outside.

(2) Woodworking power equipment generates a high noise level. Within prudent construction limitations, sound absorbent materials should be used on ceilings and walls in fixed equipment areas. Sound insulation pads should be used under the bases of rotating, vibrating, or impact machinery. Noisy equipment may be sound isolated from other work areas by solid walls or double-glazed safety-glass partitions.

(3) Adequate ventilation, temperature, and relative humidity controls are design considerations that affect the usefulness of the spaces. Relative humidity should be maintained at a level to prevent the surface oxidation of tools and machines and the delamination of wood joints. The ventilation system design must take into consideration the required air changes per occupant, and the exhaust system of the power tools. Spray booths must have exhaust fans.

(4) In particular, lumber storage and finishing areas must be sprinklered. At least one service sink with hot and cold water should be provided. A sink with sediment trap is desirable in or near the finishing room.

(5) Proper lighting reduces accidents. A minimum of 70 footcandles of shadow-free, glare-free illumination should be maintained at working surface height.

(6) The finishing room requires explosive free fixtures and switches. Circuit breakers must be provided for each machine. Outlets should be convenient to work stations for portable power tool use. A main power panel must be located at the supervisor's station.

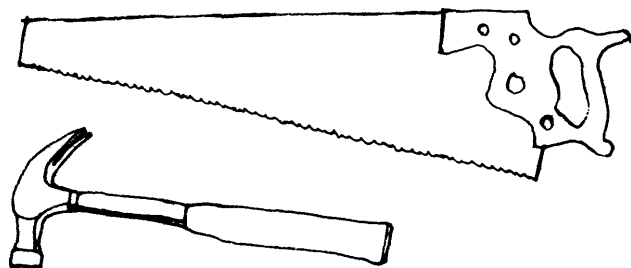

3-10 Support Activities

a. ACTIVITIES

This category covers those functions which are not assignable to a particular program. Spaces for these include the office, sales store, tool issue and storage, library/lounge/exhibit areas, studio/classroom/gallery, circulation, lobby, lockers, utility, and service areas.

b. PARTICIPANTS

All participants of the Arts and Crafts Center use the support facilities at various times. The lobby and circulation areas serve as the transitional zone for all participants entering the center. There might be as many as 200 participants in the building at one time. The office, sales store, tool issue and storage room will generally each have no more than two staff members present. Seating in the library/lounge/exhibit area should accommodate about 15. Depending on its use, as many as 30 participants might be in the studio/classroom/gallery at one time.

c. PHYSICAL REQUIREMENTS

(1) The office and its related space should be centrally located for supervision of both entrance and work areas. The sales store and tool issue area should be adjacent to the office and in direct visual control of the lobby. It is here that materials and tools are dispensed and completed projects are displayed for sale. It is desirable that the tool issue and storage room be adjacent to the sales store so that one supervisor can control both areas. The library/lounge/exhibit area is in reality an adjunct of the building circulation area adjacent to the entrance. The library itself is an informal collection of reference material relating to various arts and crafts and activities. It also must be visually supervised. The character of this space should be one of relaxation. It is the principal meeting spot for those taking part in the various programs and, as such, it is an important location for the interchange of ideas and display of work by participants.

(2) The studio/classroom/gallery is a multi-purpose area that relates to most of the arts and crafts activities. At various times it serves as a classroom, portrait studio, reception area, and exhibit space. Ideally, it should be located near the main entrance with the possibility of being opened to the library/lounge/exhibit area and lobby. It would also be desirable to have the studio/classroom/gallery open to an outdoor sculpture court. The gallery must have a system for exhibiting many types of arts and crafts. The walls might possibly have display board material or have other systems for hanging displays.

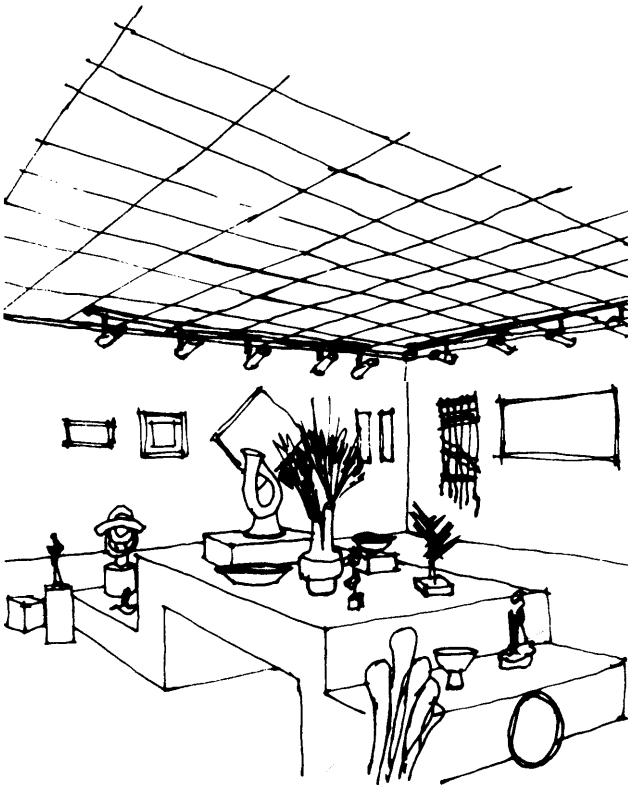

d. RECOMMENDED SPACE ALLOCATIONS

For a center of 20,650 square feet, approximately 3,100 square feet should be allocated to support activities.

Office	300 square feet
Sales Store	200 square feet
Tool Issue and Storage	300 square feet
Library/Lounge/Exhibit Area	600 square feet
Studio/Classroom/Gallery	500 square feet*
Lockers and Vending	100 square feet
Restroom	300 square feet
Circulation	800 square feet

*50% of Studio/Classroom/Gallery attributable to Photography (Paragraph 3-8).

e. RELATED SPACES

The support areas should be convenient to all major work areas.

f. FURNISHINGS - EQUIPMENT

Display cabinets and bulletin boards are required in the lobby. An outdoor display board is important to advertise the center's programs. A built-in sales counter with locked display case and a safe are required in the sales store. Lockers for work clothes should be placed away from the main entrance but convenient to the shops. The office should have attractive and functional office furniture,

including desks, chairs, file cabinets, work counters, bookshelves and display panels. Lounge chairs, sofas, low tables, table lamps, and bookcases are appropriate in the library/lounge/exhibit area. Stacking chairs, a lectern, tables, and overhead pull down projection screen should be provided in the studio/classroom/gallery. If possible, carpet is desirable throughout the main support areas.

g. TECHNOLOGICAL REQUIREMENTS

Heating, ventilating and air conditioning requirements are standard for office, classroom, and circulation spaces, with the added provision that large group use of the studio/classroom/gallery is anticipated. Electrical requirements for the studio/classroom/gallery should consider flexible overhead lighting, outlets for audio-visual equipment, and rheostat lighting control. The primary electric panel should be placed in or near the sales store or the office.

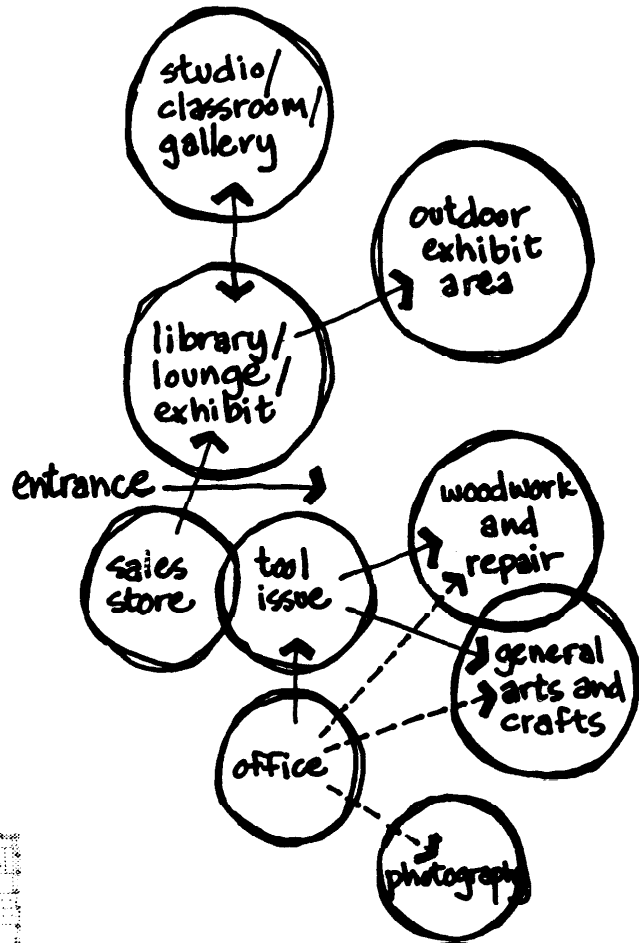
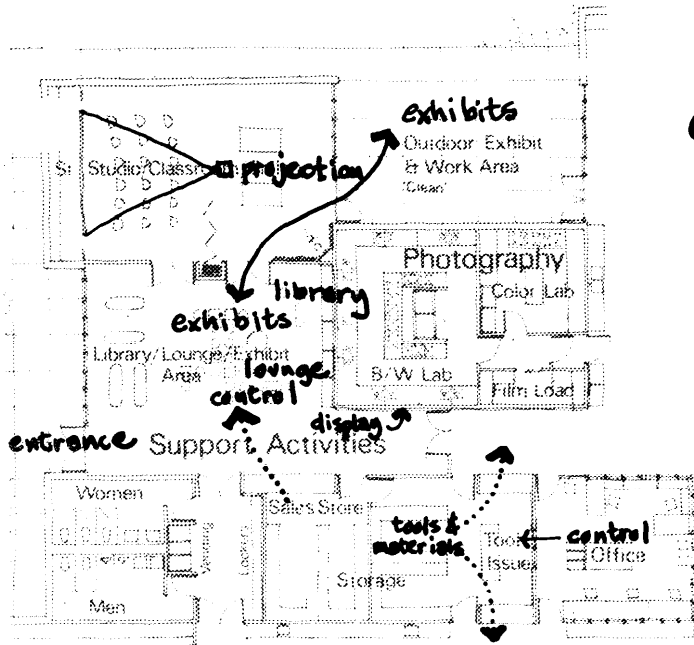

Activities

3-11 Summary of Space Allocations

Table A
 Self-Contained Example

SPACE	UNIT AREA	ACTIVITY AREA	SPACE	UNIT AREA	ACTIVITY AREA
1. GENERAL ARTS AND CRAFTS			2. PHOTOGRAPHY		
<i>Handcrafted Pottery and Ceramics</i>		1600	Monochromatic Processing Lab	600	
General Work Area	1000		Color Processing Lab	200	
Kiln Room	200		Film Loading Room	65	
Storage Area	200		Finishing Area	400	
Exterior Work Area	200**		Storage Area	100	
			Studio/Classroom/Gallery	500*	
<i>Glassblowing</i>		600	Exterior Work Area	200**	
General Work Area	400		Total		2065 square feet
Storage Area	100				
Exterior Work Area	100**		3. WOODWORK AND REPAIR		
			General Work Area	3025	
<i>Drawing and Painting</i>		1760	Power Equipment Area	2000	
General Work Area	1200		Lumber Storage Area	500	
Acid Room	60		Finish Room	400	
Storage Area	300		Project Storage Area	600	
Exterior Work Area	200**		Tool Issue Room and Supervisor's Station	300	
			Exterior Work Area	400**	
<i>Jewelry and Art Metal</i>		1200	Total		7225 square feet
General Work Area	800				
Enameling Room	200		4. SUPPORT ACTIVITIES		
Storage Area	200		Office	300	
			Sales Store	200	
<i>Weaving, Textiles and General Handicrafts</i>		1700	Tool Issue and Storage Area	300	
General Work Area	1000		Library/Lounge/Exhibit	600	
Weaving Area	400		Studio/Classroom/Gallery	500*	
Storage Area	300		Restrooms	300	
			Lockers and Vending Area	100	
<i>Sculpture and Three-Dimensional Design</i>		1400	Circulation	800	
General Work Area	1000		Total		3100 square feet
Storage Area	200				
Exterior Work Area	200**		GROSS BUILDING AREA		20,650 square feet
Total		8260 square feet			

*Space divided equally for Support Activities and Photography.

** The amount of space indicated is only half the amount which can actually be provided within the authorized space allowances, because for programming purposes, covered outdoor spaces are calculated as half the size of indoor spaces.

Table B
 Shared Space Example

SPACE	UNIT AREA	ACTIVITY AREA
1. Shared General Work Area		8425
Handcrafted Pottery and Ceramics	1000	
Drawing and Painting	1200	
Jewelry and Art Metal	800	
Weaving, Textiles and General Handicrafts	1000	
Sculpture and Three-Dimensional Design	1000	
Photo Finish Area	400	
Woodwork and Repair	3025	
2. Shared General Storage Areas		1200
Glassblowing	100	
Drawing and Painting	300	
Jewelry and Art Metal	200	
Weaving, Textiles and General Handicrafts	300	
Sculpture and Three-Dimensional Design	200	
Photography	100	
3. Exterior Work Area (clean)		400**
4. Exterior Work Area (dirty)		900**
5. Kiln Room		200
6. Ceramics Storage Area		200
7. Glassblowing Work Area		400
8. Acid Room		60
9. Enameling Room		200
10. Weaving Area		400
11. Monochromatic Photo Processing Lab		600
12. Color Photo Processing Lab		200
13. Film Loading Room		65
14. Power Equipment Area		2000
15. Finish Room		400
16. Lumber Storage Area		500
17. Project Storage Area		600
18. Office		300
19. Sales Store		200
20. Tool Issue and Storage Area		600
21. Library/Lounge/Exhibit		600
22. Studio/Classroom/Gallery		1000
23. Restrooms		300
24. Lockers and Vending Area		100
25. Circulation		800
GROSS BUILDING AREA		20,650 square feet

* * The amount of space indicated is only half the amount which can actually be provided within the authorized space allowances, because for programming purposes, covered outdoor spaces are calculated as half the size of indoor spaces.

CHAPTER 4

Space Planning Concepts

4-1 Conceptual Diagrams

a. Space planning involves arranging the elements of a plan in response to the functional requirements of the programmed activities. The interrelationships of the activities themselves are the most variable factors in the interpretation of the program. Planning, however, must take into account the probability that future space requirements will change because of program modifications.

b. Most buildings incorporate two types of spaces: committed and uncommitted. Committed spaces are those that are designed or used for only a particular activity because of specific requirements or spatial configuration. Committed space is difficult to adapt to new uses. On the other hand uncommitted spaces have an amorphous character, allowing them to be used for many unspecialized functions; it allows multiple use and flexibility for change.

c. Arts and crafts activities require both types of spaces. Part of the planning process is to identify and, where possible, consolidate those non-conflicting spaces which have similar environmental requirements, while separating those conflicting ones.

d. The conceptual diagrams that follow illustrate design concepts for the building as a whole responding to differing climatic conditions, site constraints, and space use requirements.

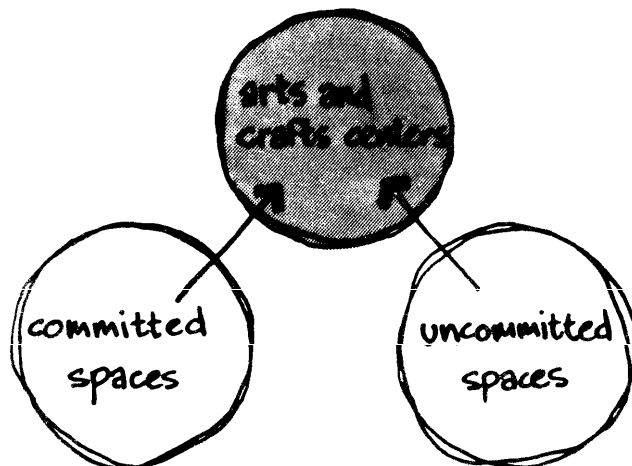

Space Types

Diagrams

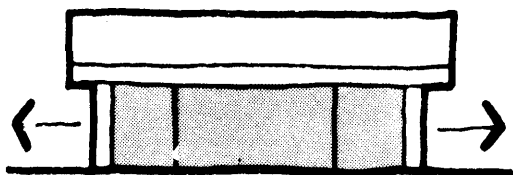

- (1) *Horizontal* design concept best suits an unrestricted level site, with direct indoor-outdoor access and flow between activities. Initial construction cost is lower and expansion can occur more readily.

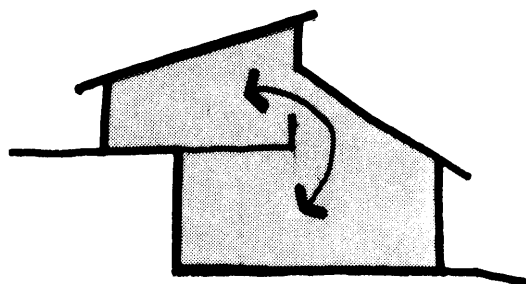

- (2) *Vertical* design concept may be required to meet site or terrain restrictions but care is required for vertical continuity and communication.

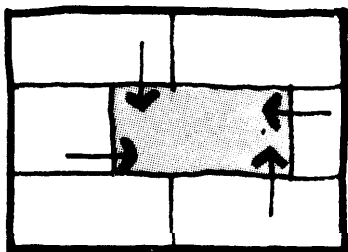

- (3) *Inner-Directed* design concept shuns severe climate or surroundings with functional areas oriented around a central focus such as a courtyard used as an exterior work area.

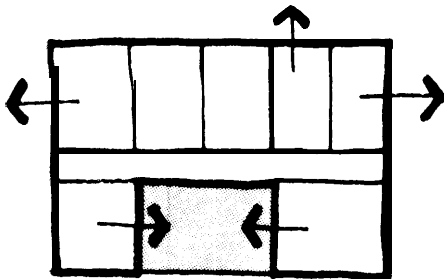

(4) *Outer-Directed* design concept takes maximum advantage of surrounding amenities, particularly in mild climates. Functional areas may be oriented around exterior work areas.

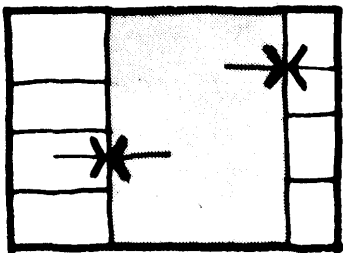

(5) *Shared Space* design concept maximizes the use of uncommitted space to allow multiple use and flexibility for change. There is free circulation and activity mix, with compatible activities grouped together and conflicting ones separated; i.e., clean vs. dirty and quiet vs. noisy. The use of committed space for visual and acoustic separation is held to the minimum necessary.

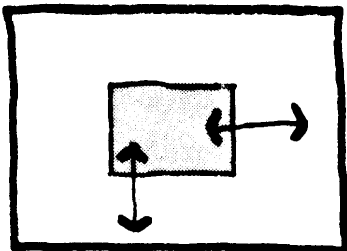

(6) *Central Core* design concept develops a central focus with functional areas oriented around support facilities.

4-2 Affinity Matrix

a. In designing any facility there are many relationships and interrelationships between activities which must be considered so that the most functional plan can be developed. One means of graphically describing these relationships is with an affinity matrix.

b. The matrix shown on this page charts two types of relationships which must be considered when designing an Arts and Crafts Center, The first is physical relationships which shows whether it is desirable or not to have one area immediately adjacent to another. By assigning values to the desirability, an evaluation can be made and recorded. As an example, one relationship is shown by a shaded line. By looking at this example, we can see that it is very desirable to have the Control Office adjacent to the General Handicrafts Area so that it can be supervised.

c. The second relationship shown on this matrix is environmental incompatibilities where the effects of the operation of one activity is incompatible with another. The example shown indicates that it is incompatible to have the Black and White Photographic Lab adjacent to the Ceramics Area due to the dust created by the ceramics operation.

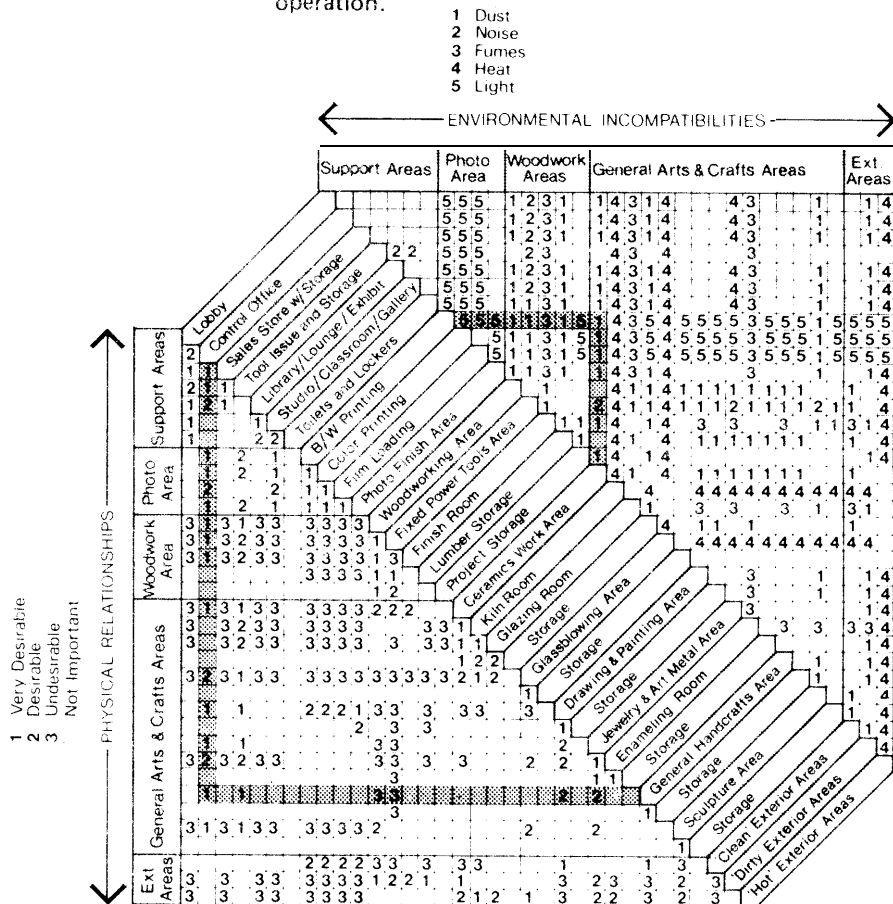

4-3 Functional Layouts

a. The following functional layouts indicate various alternatives for the arrangement of the major areas of an Arts and Crafts Center. The layouts generally respond to the broad physical relationships and environmental incompatibilities shown in the Affinity Matrix.

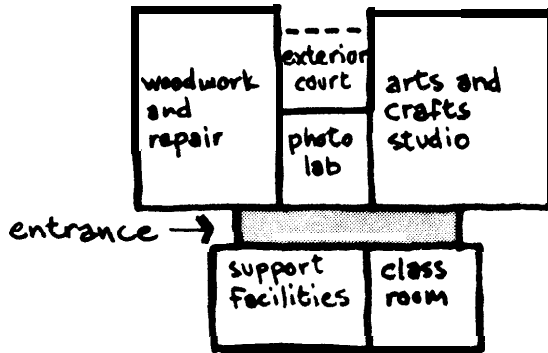

b. Layouts utilizing the *horizontal* and *outer-directed* design concepts. The two layouts shown have alternative entrance locations which may result from differing site constraints or opportunities. These layouts show separation of the four major elements of the Arts and Crafts Center.

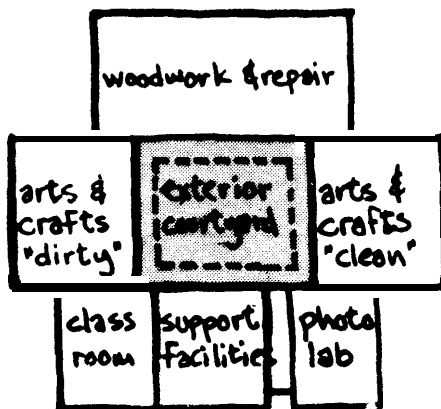
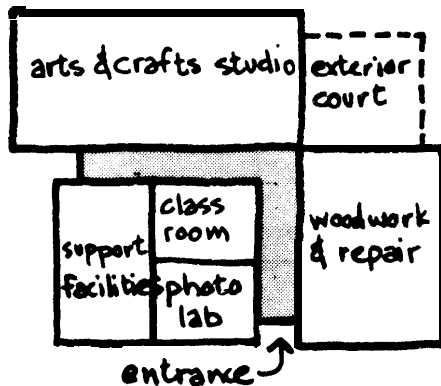

c. Layout utilizing the *horizontal* and *inner-directed* design concepts. The work areas focus on a central courtyard which can be used as an outdoor work area where weather dictates the need for shelter and protection.

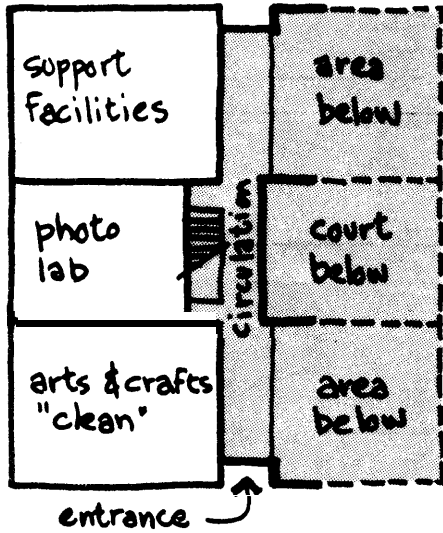

d. Layout utilizing the *vertical* and *outer-directed* design concepts. Due to the nature of some sites, this layout may have to be used in order to best meet the natural terrain of the land. This could form an exciting building visually but care must be taken to make sure it will function properly.

upper level

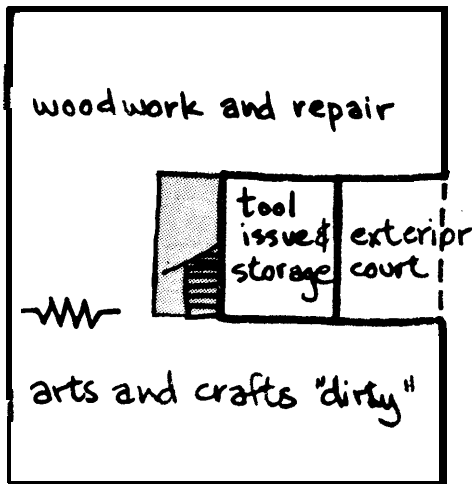

lower level

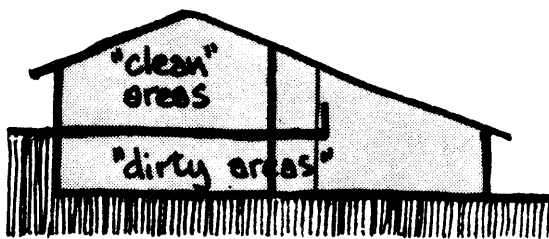

cross section

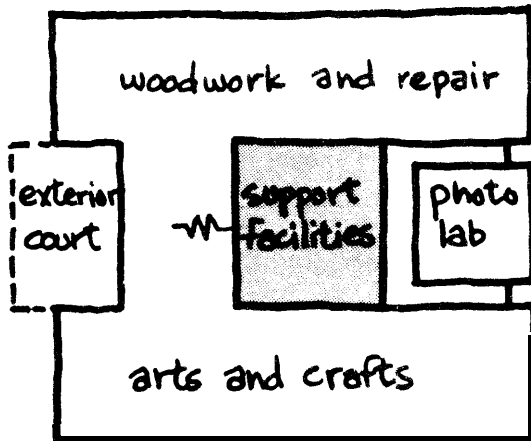

d. Layout utilizing the *central core* and *outer-directed* design concepts. The layout shows work areas oriented around centralized support facilities. This layout permits good visual control over all areas including circulation areas. It could also provide for convenient tool issue and storage for all major activities.

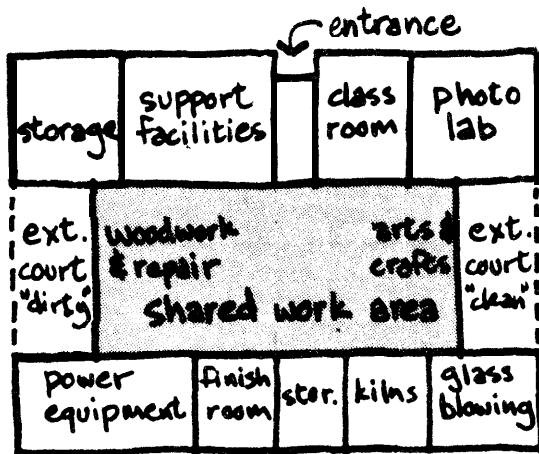

e. Layout utilizing the *shared space*, *outer-directed* and *horizontal* design concepts. The layouts isolate only those specific sub-activities such as power tool operations, kiln firings or film development which are clearly incompatible. Other activities share multi-use areas which are easily altered to accommodate changing activity needs. The second layout also employs the *central core* concept with regard to support facilities such as visual control and tool issue. This last layout is the scheme which is further developed in Chapter 5.

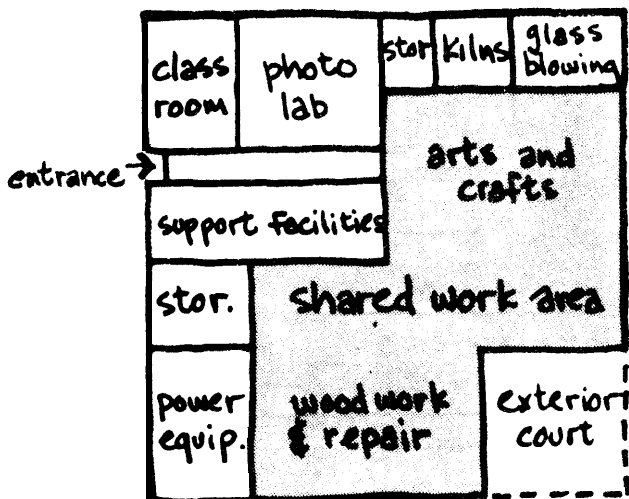

CHAPTER 5

Illustrative Examples

5-1 New Facility Design

a. DOD Manual 4270.1 -M establishes specific space allowances for certain types of facilities. Design premises are based on an Arts and Crafts Center of 20,650 gross square feet, exclusive of mechanical equipment space. This is the maximum space allowance for a military population of 20,000 to 25,000. The area within the Arts and Crafts Centers basically conforms to the following space distribution:

Activity	Percent of Total Areas
General Arts and Crafts	40%
Photography	10%
Woodwork and Repair	35%
Support Activities	15%

b. It should be recognized that the percentage of total area allocation listed for the activities above may vary as the gross building area changes. For instance, in the larger Arts and Crafts Centers more space might be devoted to new or expanded programs in general arts and crafts than to a proportional increase in the size of the woodwork shop. Nevertheless, the percentages given are a solid base for providing adequate facilities for a diversified program.

c. There are two example space allocation summaries at the end of Chapter 3. Example A follows the conventional pattern of separating the building into four self-contained areas for general arts and crafts, photography, woodwork and repair, and support facilities. Example B follows the concept of shared space and separates only incompatible or specialized activities into committed areas. The identification of specific areas is much less detailed because of use of larger uncommitted spaces to accommodate many activities.

d. A design solution based on the shared space concept follows. The shared space concept was chosen to be developed as the example solution because it offers the greatest degree of flexibility and is generally the approach advocated by this guide.

Design Solution

view a

elevation b

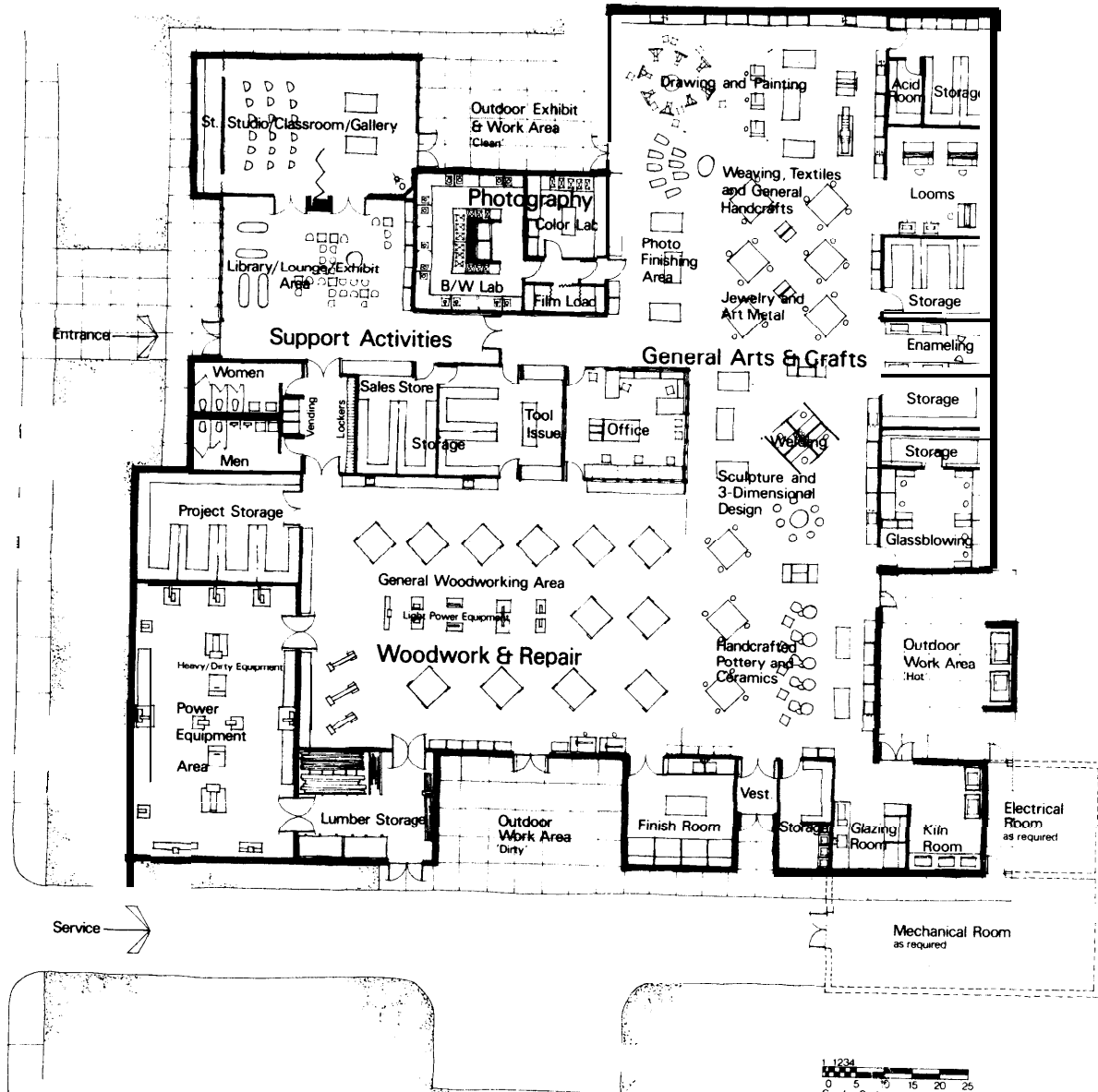

elevation c

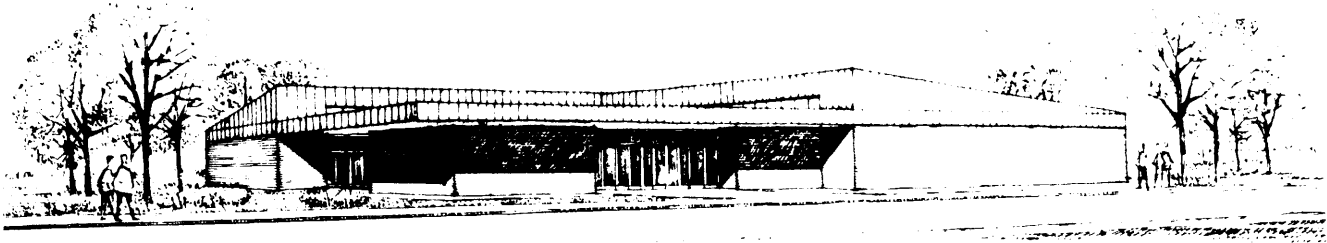

view a

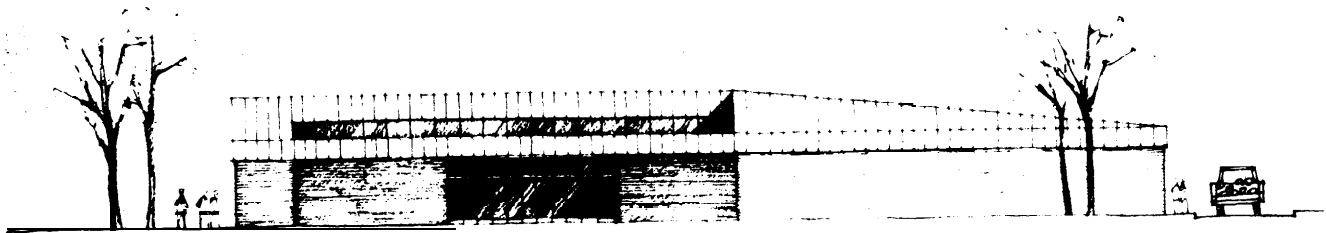

elevation b

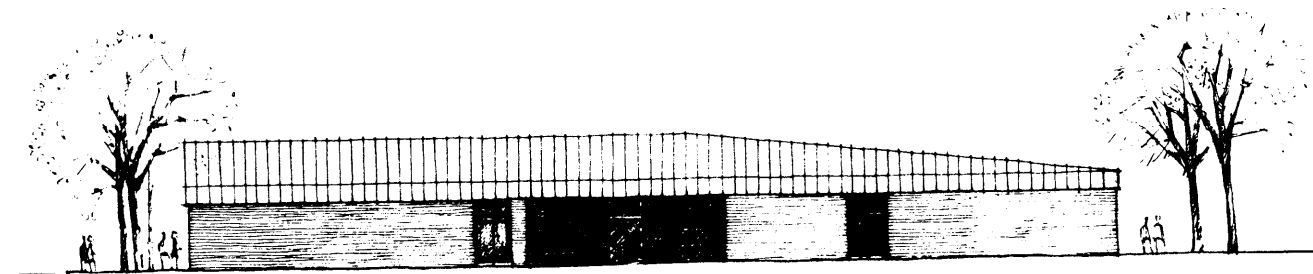

elevation c

5-2 Modification and Expansion of Existing Facilities

Existing arts and crafts facilities vary considerably in their adequacy for housing the range of activities required locally. Some programs operate in buildings designed and constructed specifically as Arts and Crafts Centers. Others utilize found spaces of various types. However, regardless of the type or age of the facilities, it should be expected that space layouts will periodically need modifications as programs change.

b. The following illustrations are presented to demonstrate the planning options that might be used in modifying and/or expanding existing arts and crafts facilities. The illustrations emphasize a greater use of shared spaces, as has been advocated in this Design Guide.

c. The floor plan shown below is the Arts and Crafts Shop prepared as Definitive Design No. 31-21-11, dated 12 June 1967. The size of this facility is 9400 square feet, and it has been the prototype for installations with military strengths between 7,001 and 10,000 personnel.

d. The concepts for modifying and expanding this design have been developed without emphasis being placed on any particular structural system that might have been incorporated in an actual building. The Definitive Design could be interpreted in a variety of systems ranging from long span steel joist framing to bearing walls with short span concrete roof planks. The assumption has been made, however, that the building would have some committed space which, under most reasonable circumstances, would be uneconomical to alter. These spaces are the photo lab and toilet rooms which contain the majority of the plumbing elements in the building, and the mechanical equipment room where included in the actual facility.

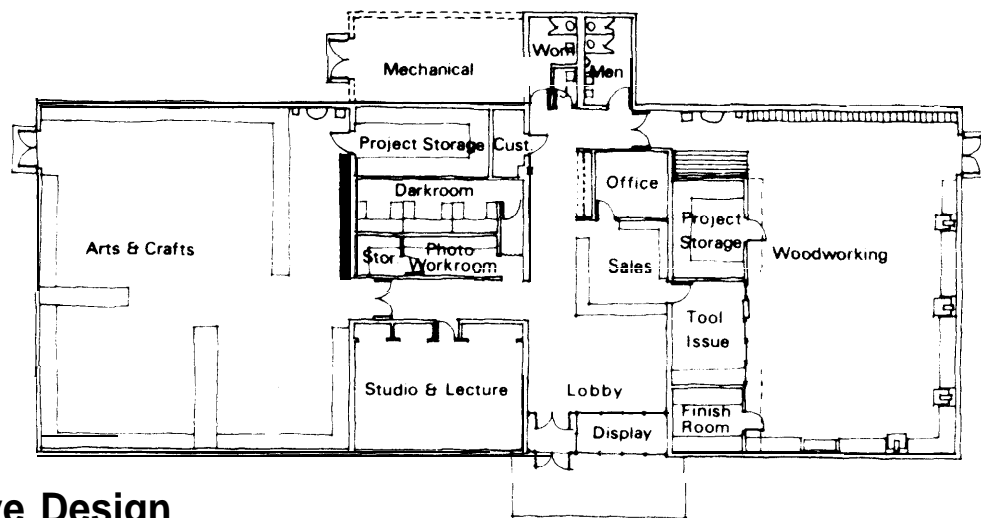

Existing Definitive Design

e. Example A is the simplest of the conversions illustrated. The solution provides a direct link between the arts and crafts and woodworking areas, and encloses the minimum number of activities requiring isolation. The studio/classroom/gallery may be opened up by means of a folding partition to increase flexibility for a wide variety of programs and activities, especially those relating to photography, exhibits, demonstrations, and those crafts not requiring special equipment.

f. In Example B, a more drastic approach was taken. The intent was to open up as much of the interior space as possible for general project work. Thus the studio/classroom/gallery was moved into the center of the building and can be part of the shared multi-use work space or can be divided off by folding partitions.

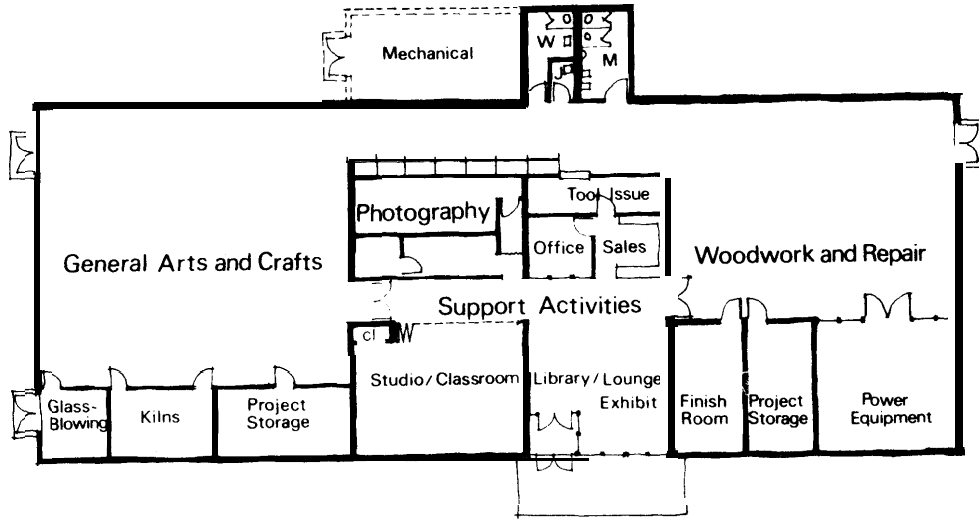

Example A

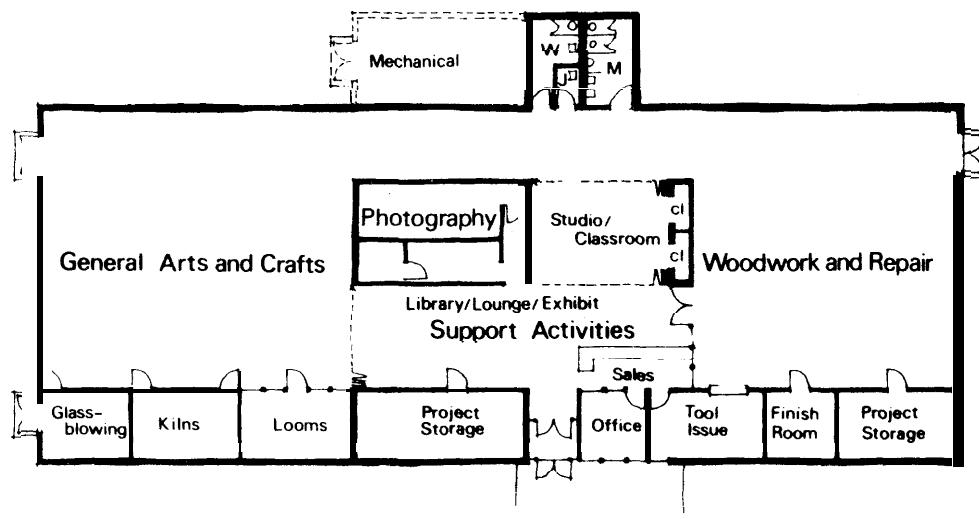

Example B

g. In Example C, the major activity areas have been expanded horizontally to create outdoor work areas at either end of the building. The rectilinear character of the main structure is maintained and specialized activities are concentrated around the perimeter. The photography area was expanded by adding an additional laboratory and flexibility is gained by relocating the studio/classroom/gallery to a new building element to the front of the basic building.

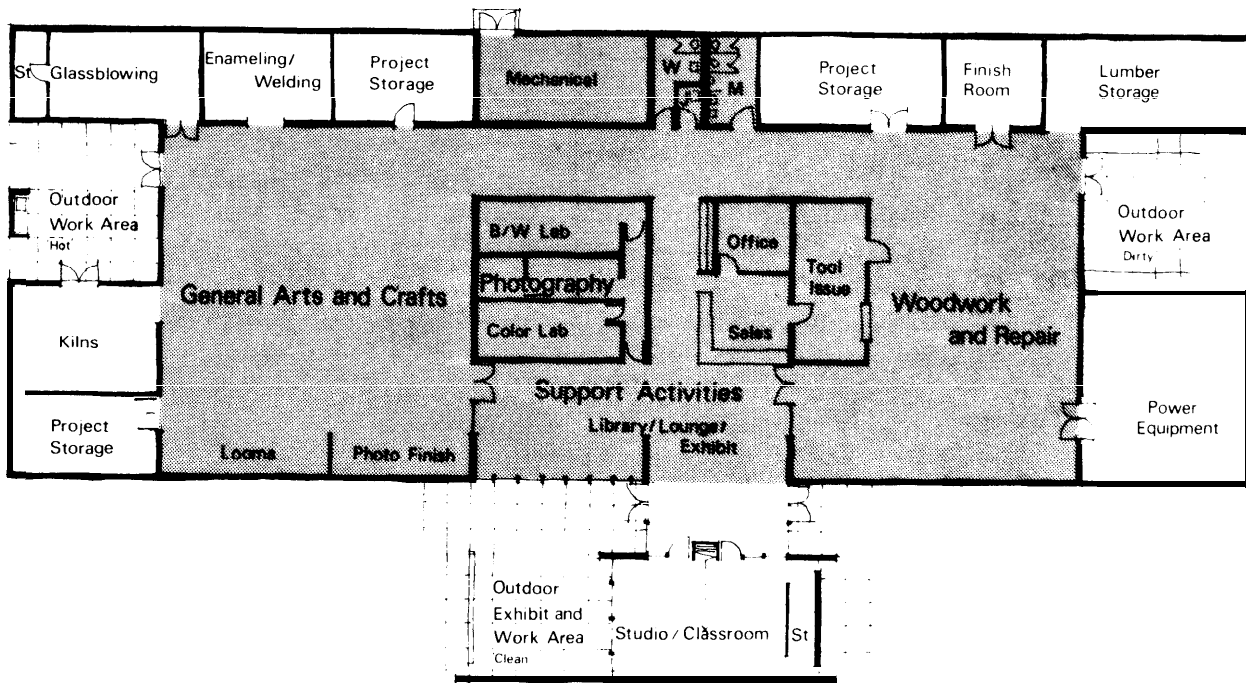

Example C

h. Example D suggests the possibility of expansion to the rear of the building with the use of a large shared outdoor work area. For illustrative purposes, it has been assumed in this instance that no central mechanical space was required.

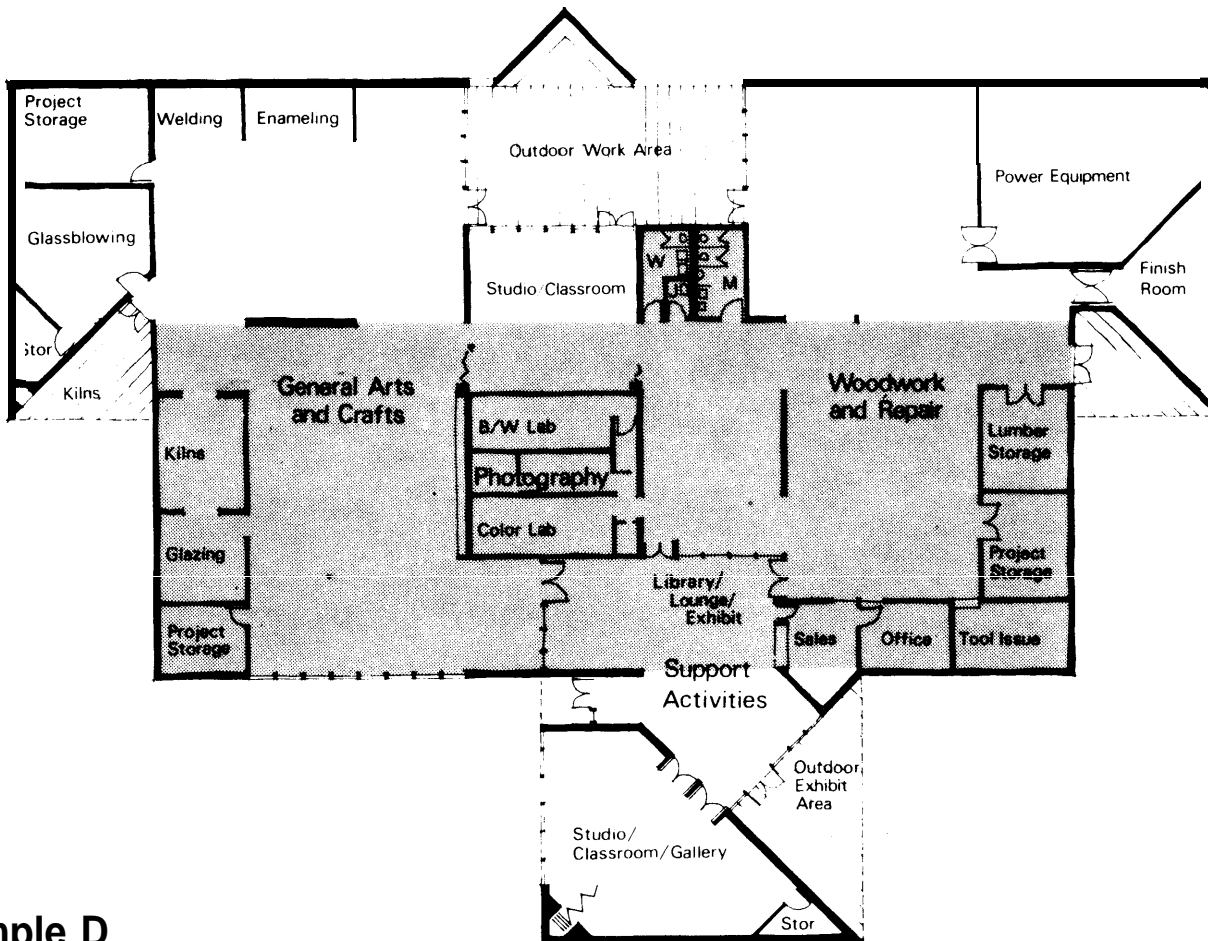

Example D

